

# ASTERIX & OBELIX

BS KRAJOBRAZNA ARHITEKTURA - KONSTRUKCIJE I MATERIJALI U KRAJOBRAZNOJ ARHITEKTURI - AK. GOD. 2019./2020.  
NOSITELJ KOLEGIJA: izv. prof. art. STANKO STERGARŠEK, dipl. ing. arh., ASISTENT: ANETA MUDRONJA PLETENAC, dipl. ing. arh.

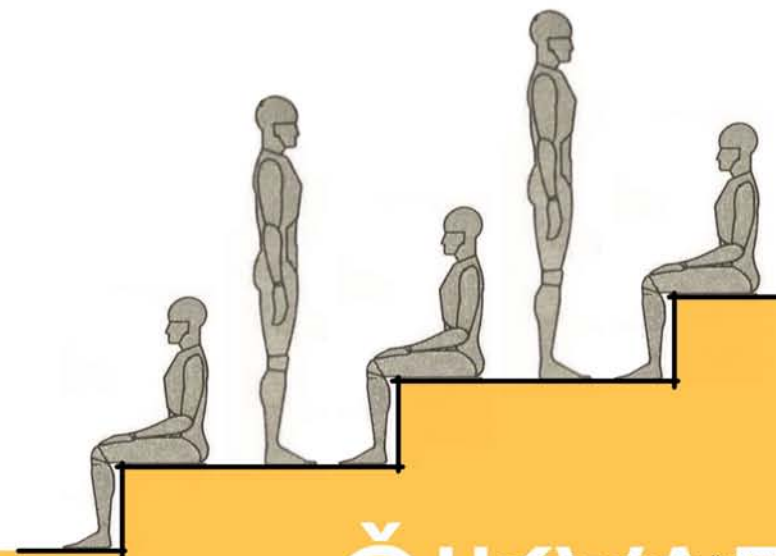

ČIKVARI

STUDENT: ANDREJ ČIKVARI  
DATUM PREDAJE: 16.7.2020.

- 
- 1 IDEJNO RJEŠENJE - OBLIKOVNA OSNOVA** tlocrt 1:200
  - 2 KARAKTERISTIČNI PRESJECI** 1:200
  - 3 UREĐAJNA OSNOVA** tlocrt 1:200
  - 4 SUSTAV POTPORNIH ZIDOVA** tlocrt 1:200
  - 5 PRESJEK A** 1:100
  - 6 PRESJEK B** 1:100
  - 7 DETALJ TRIBINA - KONZOLNE STEPENICE** presjek 1:20
  - 8 DETALJ TRIBINA - KONZOLNA SJEDALA** presjek 1:20
  - 9 DETALJ KONZOLNOG SJEDALA 1** presjek 1:10
  - 10 DETALJ KONZOLNOG SJEDALA 2** nacrti 1:5
  - 11 MATERIJALI**

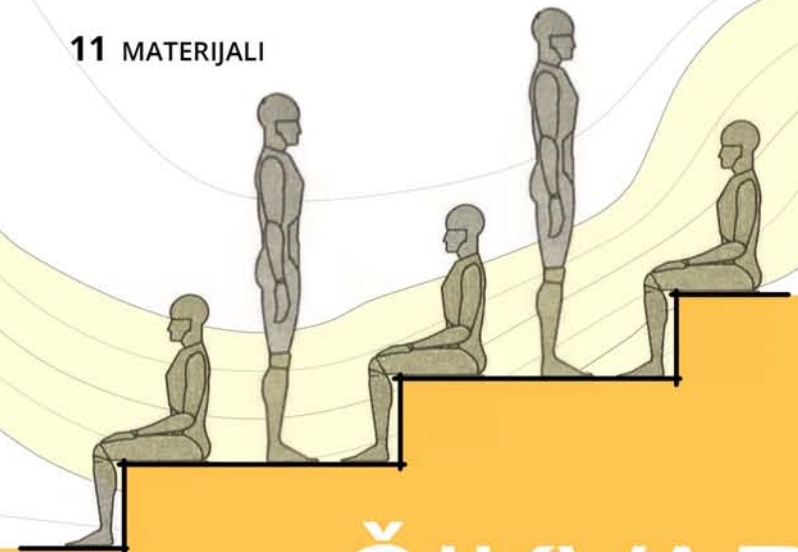

KRAJOBRAZNO UREĐENJE ŠUMSKE POZORNICE  
S GLEDALIŠTEM I POPRATNIM SADRŽAJIMA  
ASTERIX & OBELIX



TLOCRT

- stablo
- opločana površina za pripremu hrane
- polukružne stepenice
- prilazni trg
- ognjište
- most
- terasa II (vidikovac) / štandovi
- terasa I
- terasa III
- dizalo
- zelene stepenice
- zeleni krov / javni toaleti
- kameni obelisk
- ophodna staza
- LED zaslon
- pozornica
- rampa
- tribine (gledalište)
- stepenice
- potporni zid

KRAJOBRAZNO UREĐENJE ŠUMSKE POZORNICE  
S GLEDALIŠTEM I POPRATNIM SADRŽAJIMA  
ASTERIX & OBELIX

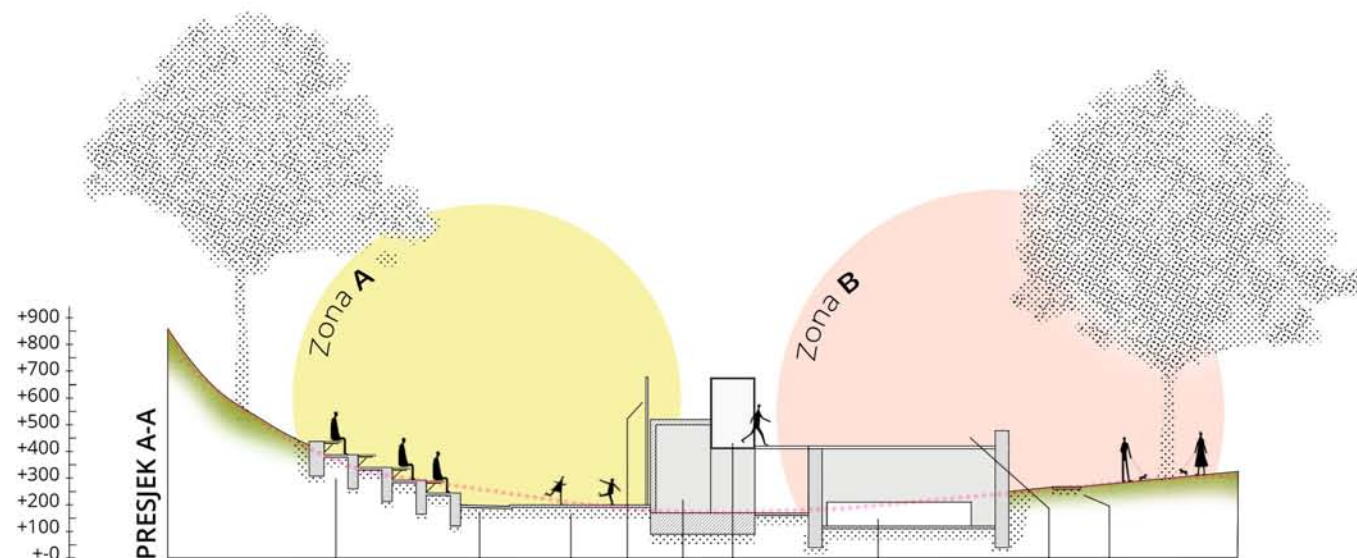

tribine ophodna staza izvedbeni prostor toaleti dizalo šandovi s hranom i pićem krovnna terasa polukružne stepenice

LED zaslon

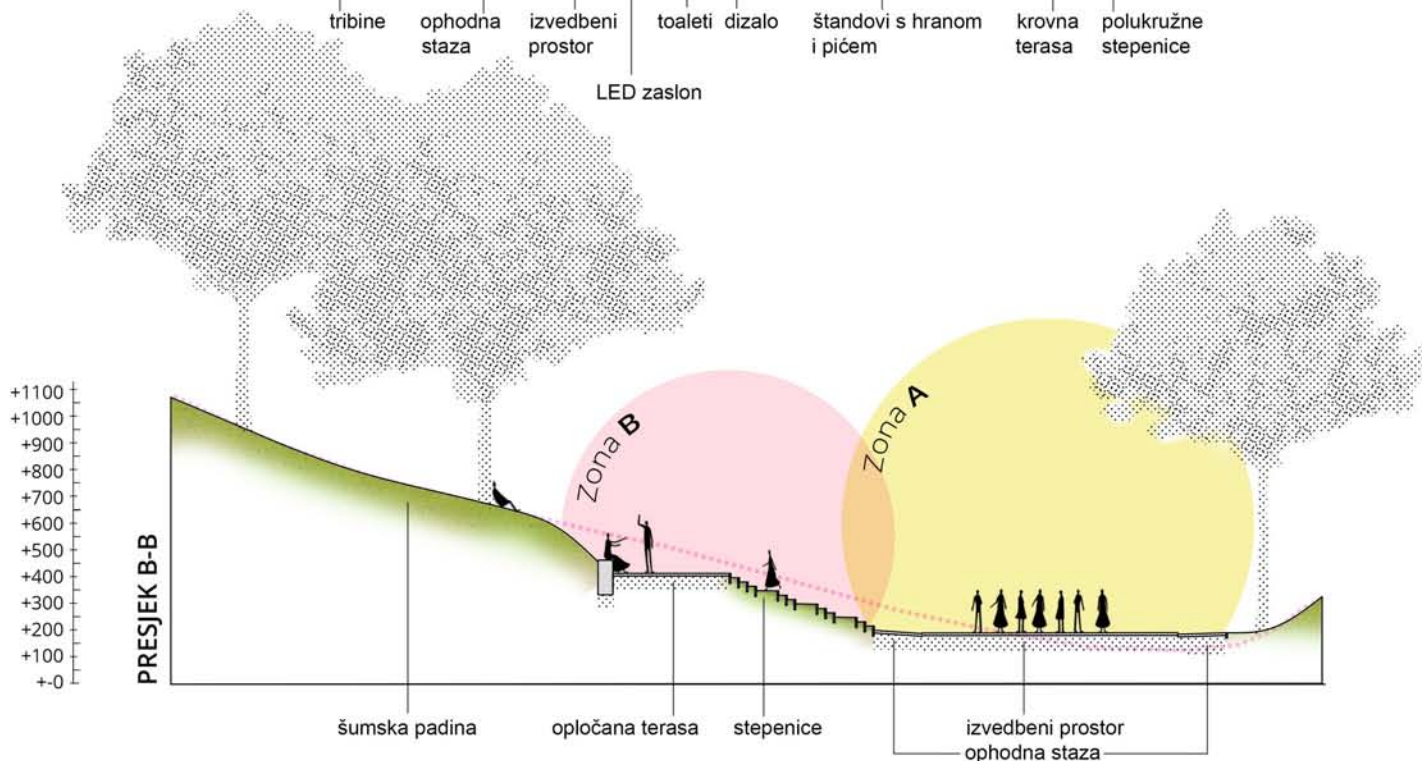

šumska padina opločana terasa stepenice izvedbeni prostor ophodna staza

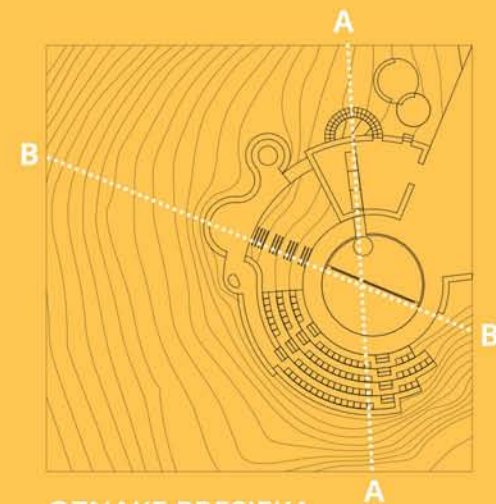

OZNAKE PRESJKA  
TLOCRT M 1:500

**ZONA A - izvedbe**

- koncerti
- predstave
- filmske projekcije

**ZONA B - slobodni boravak**

- konzumacija hrane i piće
- socijalizacija
- odmor u prirodi
- rekreacija

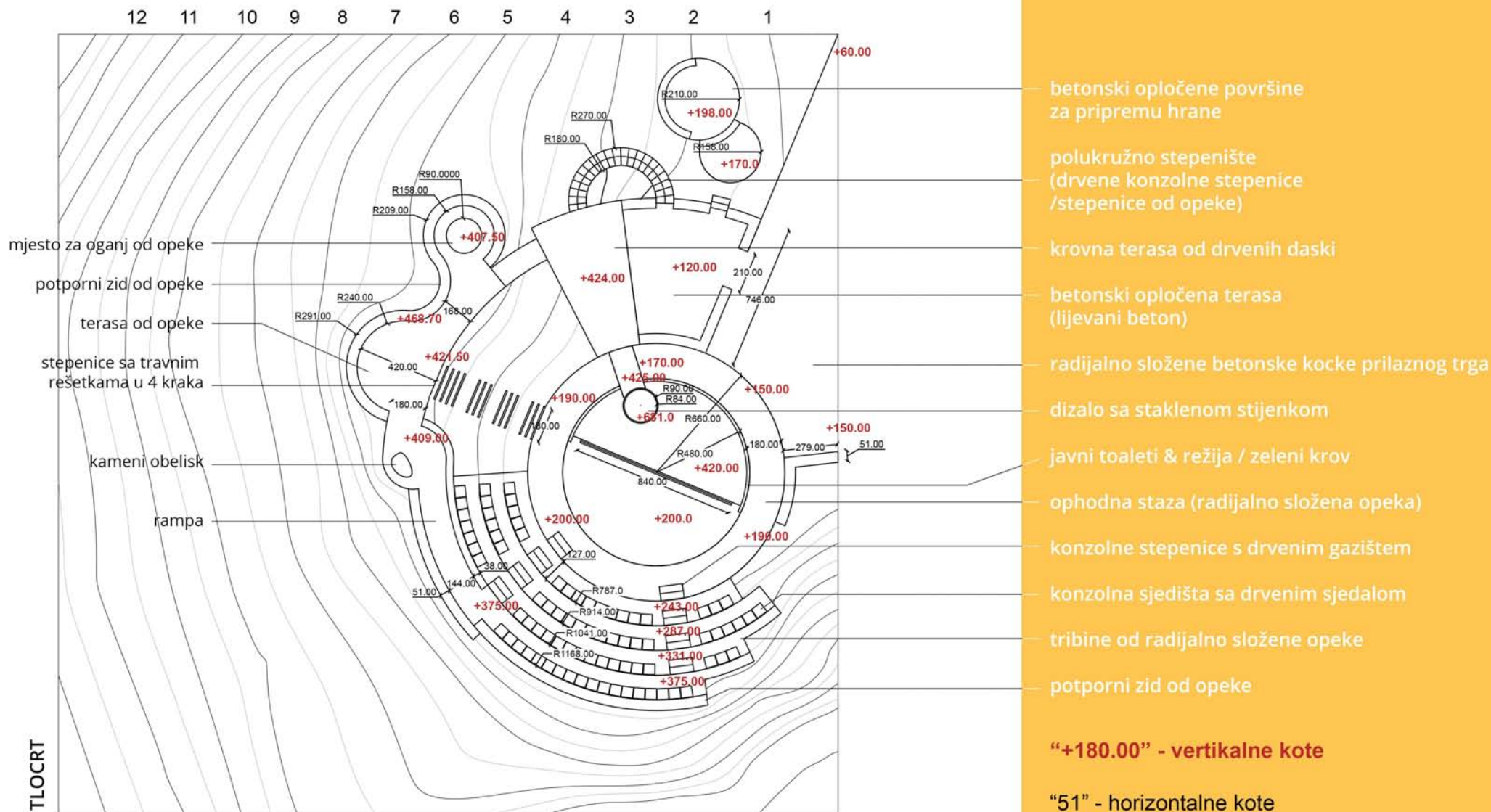

KRAJOBRAZNO UREĐENJE ŠUMSKE POZORNICE  
S GLEDALIŠTEM I POPRATNIM SADRŽAJIMA  
**ASTERIX & OBELIX**

TLOCRT

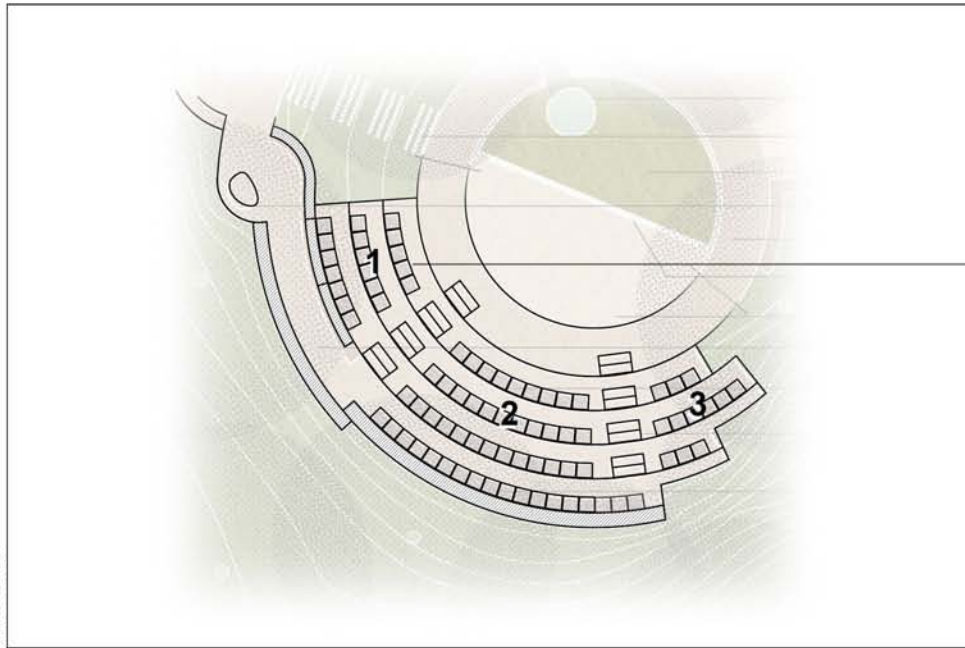

KONZOLNA SJEDALA

- 1** SJEDENJE LIJEVO: 18
- 2** SJEDENJE SREDINA: 51
- 3** SJEDENJE DESNO: 12
- UKUPNO: 81**

POVRŠINSKI IZGLED TRIBINA  
SA SJEDALIMA I KONZOLNIM  
STEPENICAMA

TLOCRT

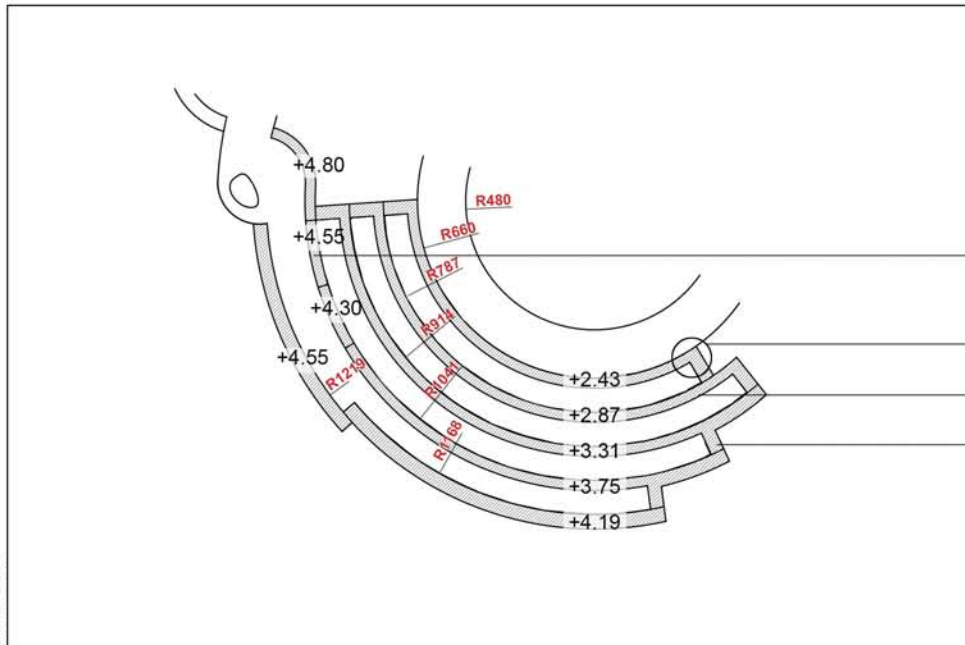

STEPENASTO UZDIGNUTI  
DIO ZIDA U 3 SEGMENTA

SPOJ ZIDA "38" I "51"

POTPORNI ZID "38"

POTPORNI ZID "51"

SUSTAV POTPORNIH ZIDOVA OD  
OPEKE

\* HORIZONTALNA  
FUGA JE 1 CM

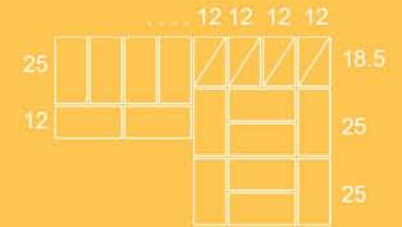

parni sloj

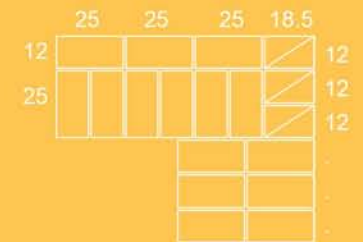

neparni sloj

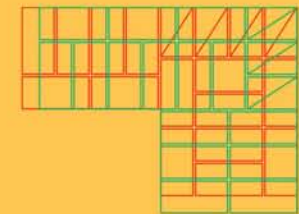

preklop

TLOCRTNI PRIKAZ SPOJA  
POTPORNIH ZIDOVA  
M 1:20

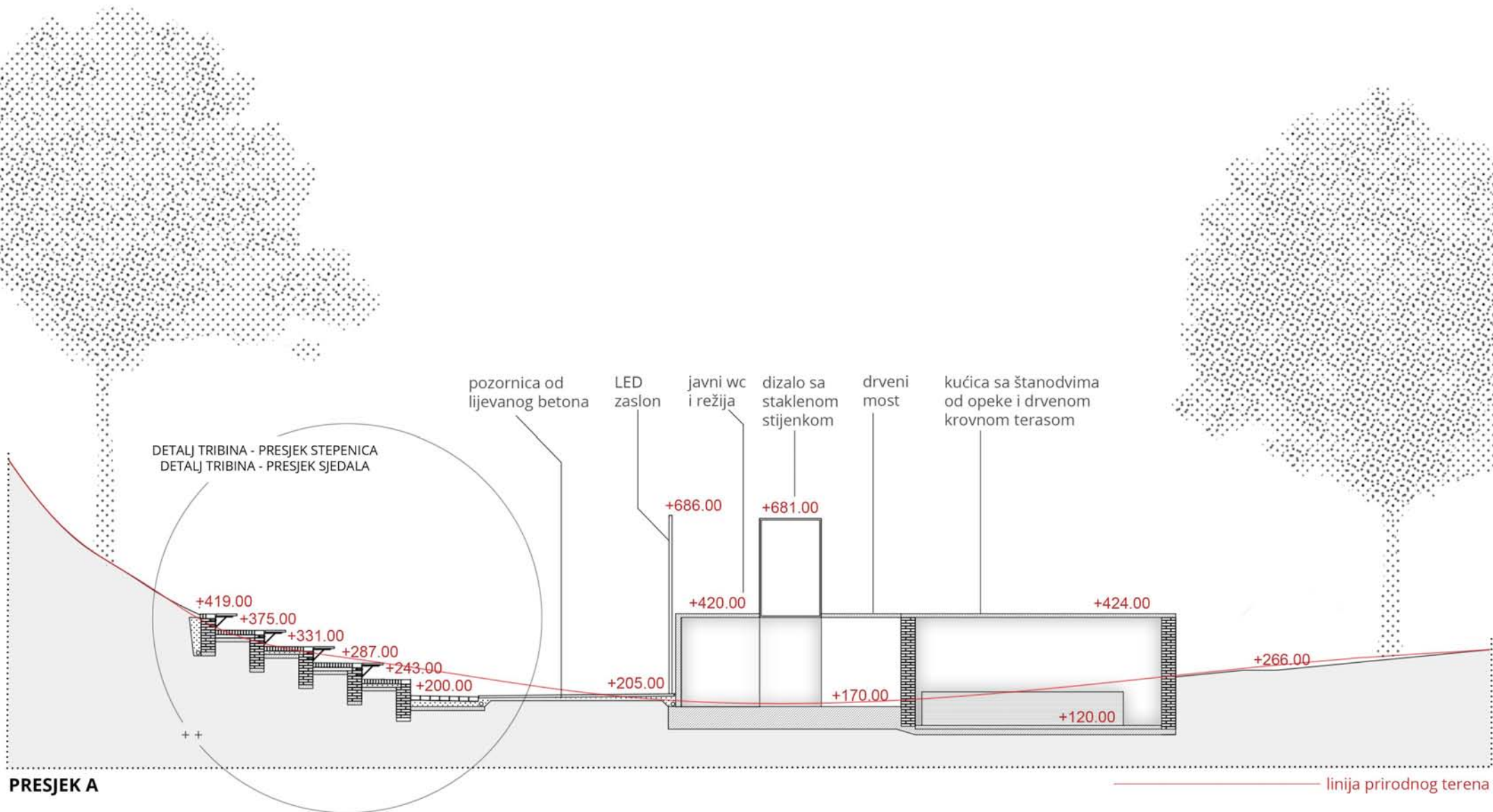

PRESJEK A

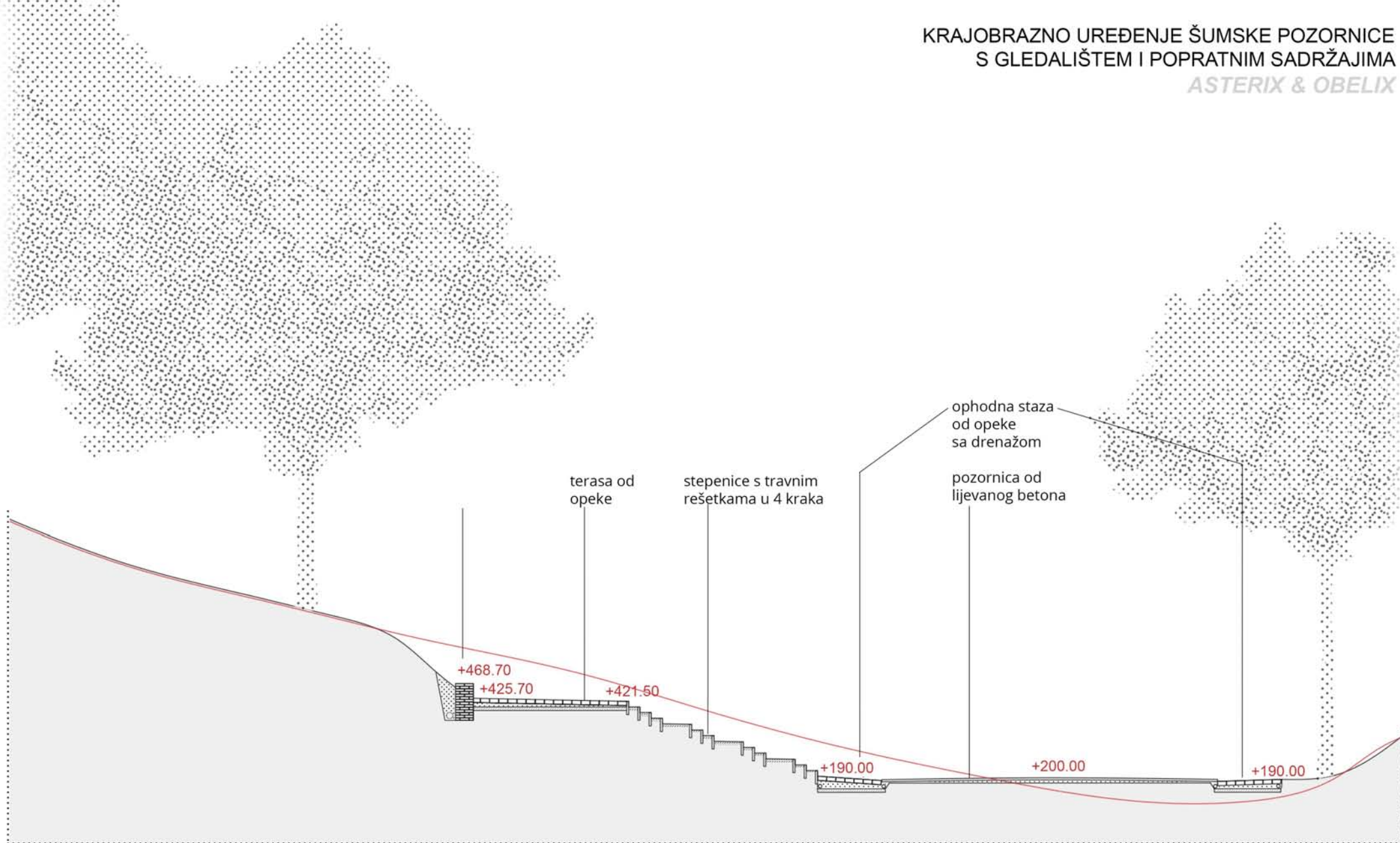

PRESJEK B



# KRAJOBRAZNO UREĐENJE ŠUMSKE POZORNICE S GLEDALIŠTEM I POPRATNIM SADRŽAJIMA

ASTERIX & OBELIX

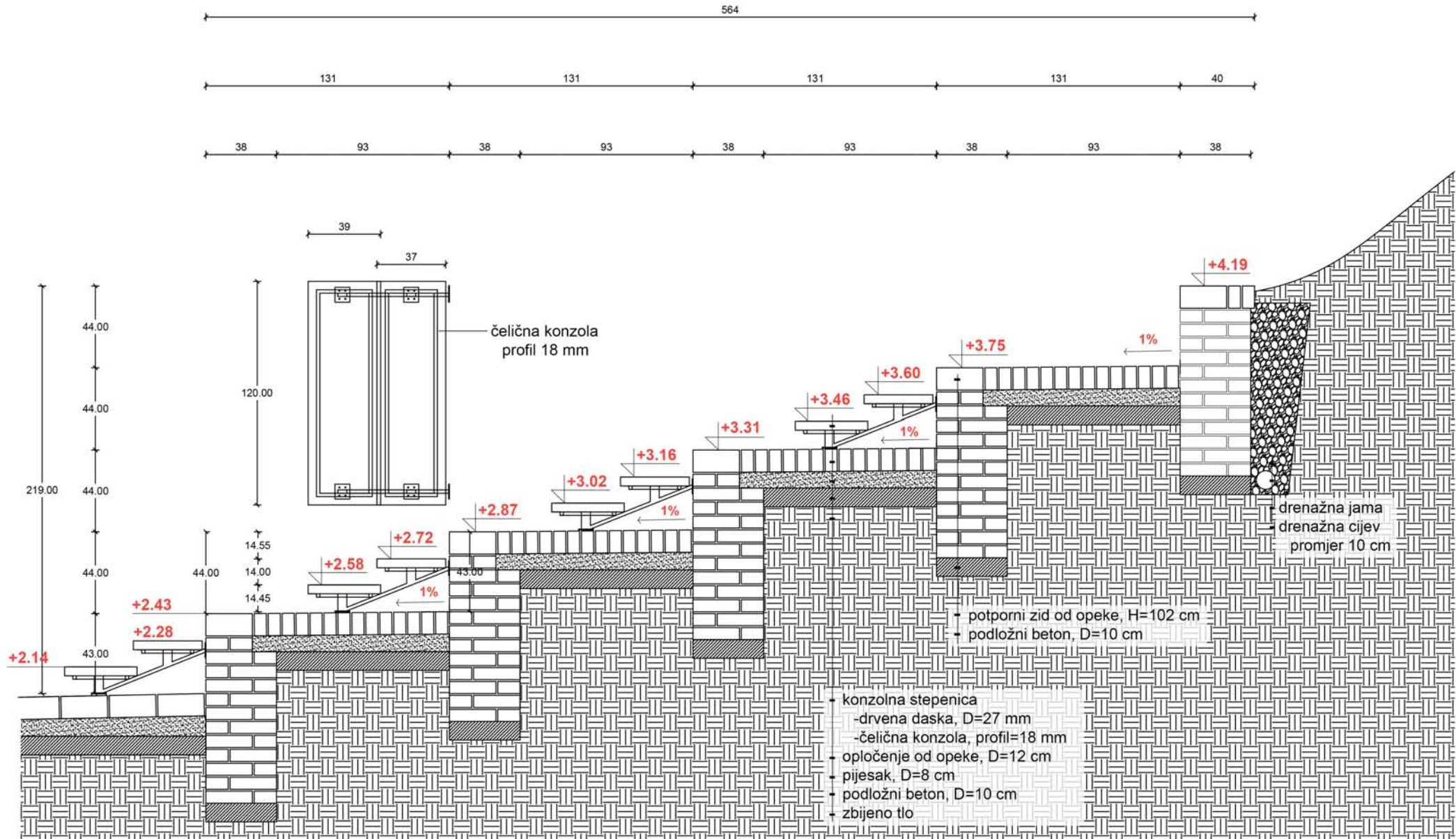

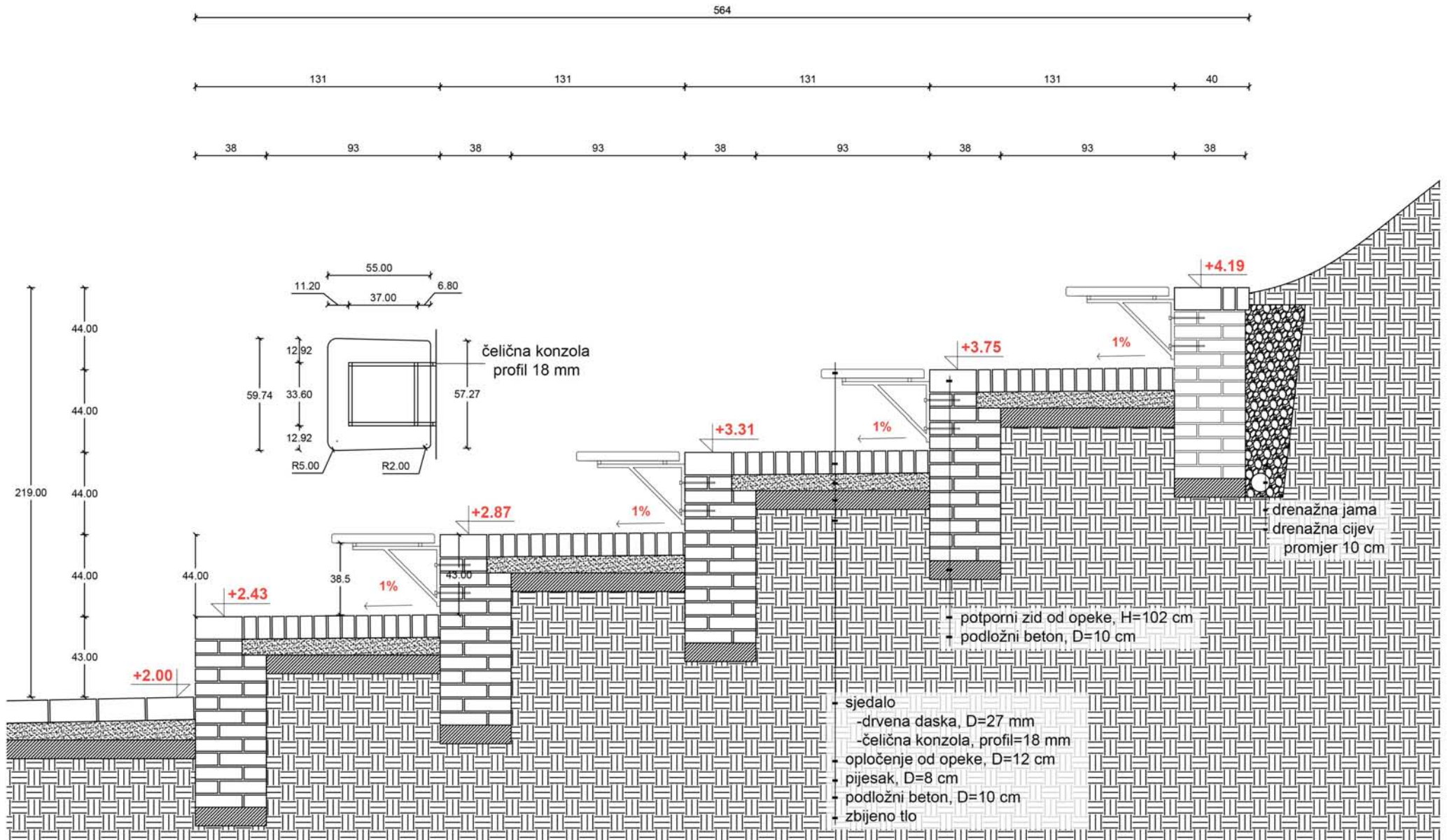



KRAJOBRAZNO UREĐENJE ŠUMSKE POZORNICE  
S GLEDALIŠTEM I POPRATNIM SADRŽAJIMA

ASTERIX & OBELIX

BOČNI POGLED

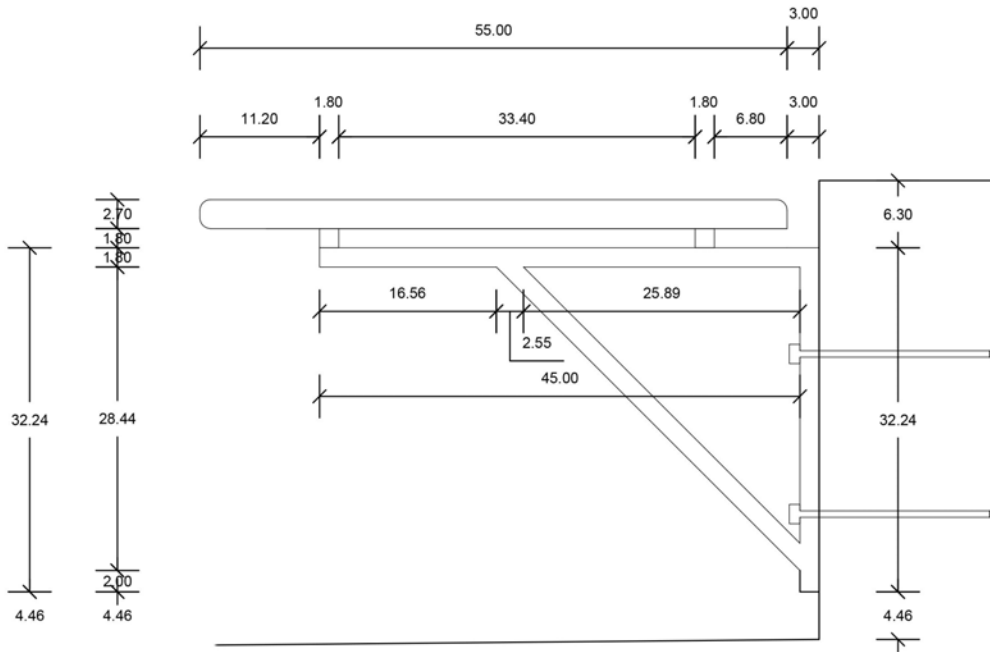

PREDNJI POGLED

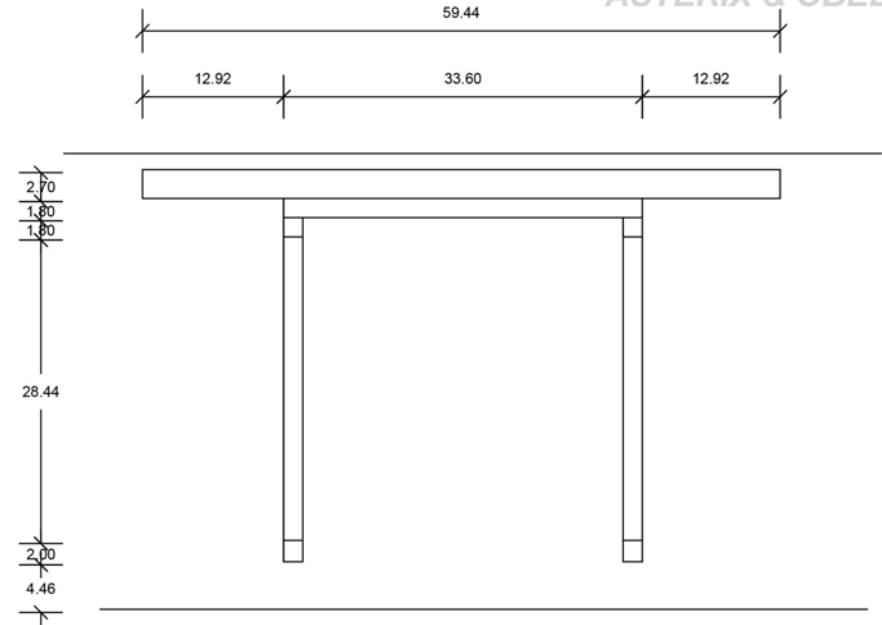

TLOCRT

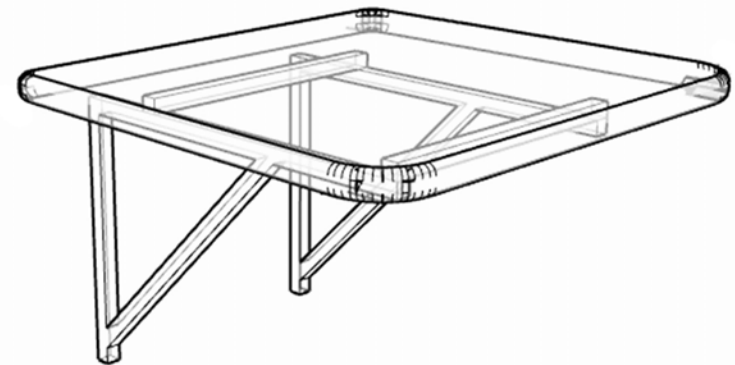
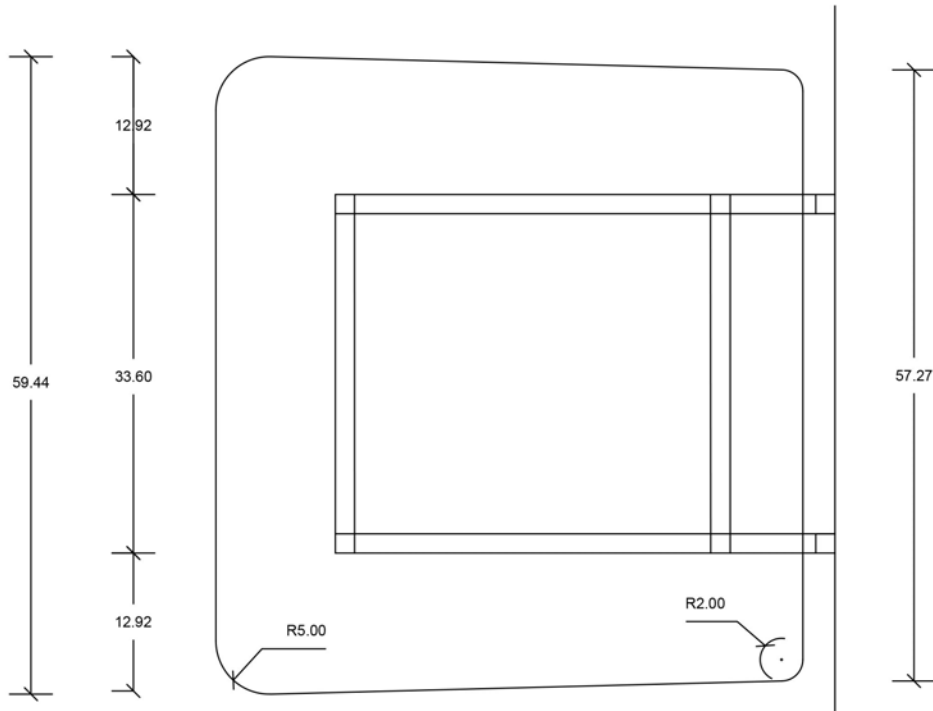



**OPEKA**

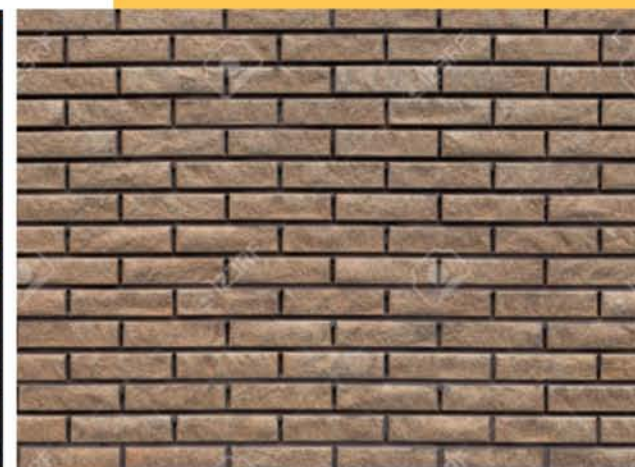

**BETON**

**DRVO**



# LJETNO KINO ASTERIX I OBELIX

IVA KNEŽEVIĆ

AKADEMSKA GODINA 2019./2020.

BS KRAJOBRAZNA ARHITEKTURA

MODUL: KONSTRUKCIJE I MATERIJALI U KRAJOBRAZNOJ ARHITEKTURI

NOSITELJI MODULA: STANKO STERGARŠEK dipl. ing. arh. ; ASISTENT: ANETA MUDRONJA PLETENAC mag. ing. arh. i urb.







PRESJEK 1-1

MI:200

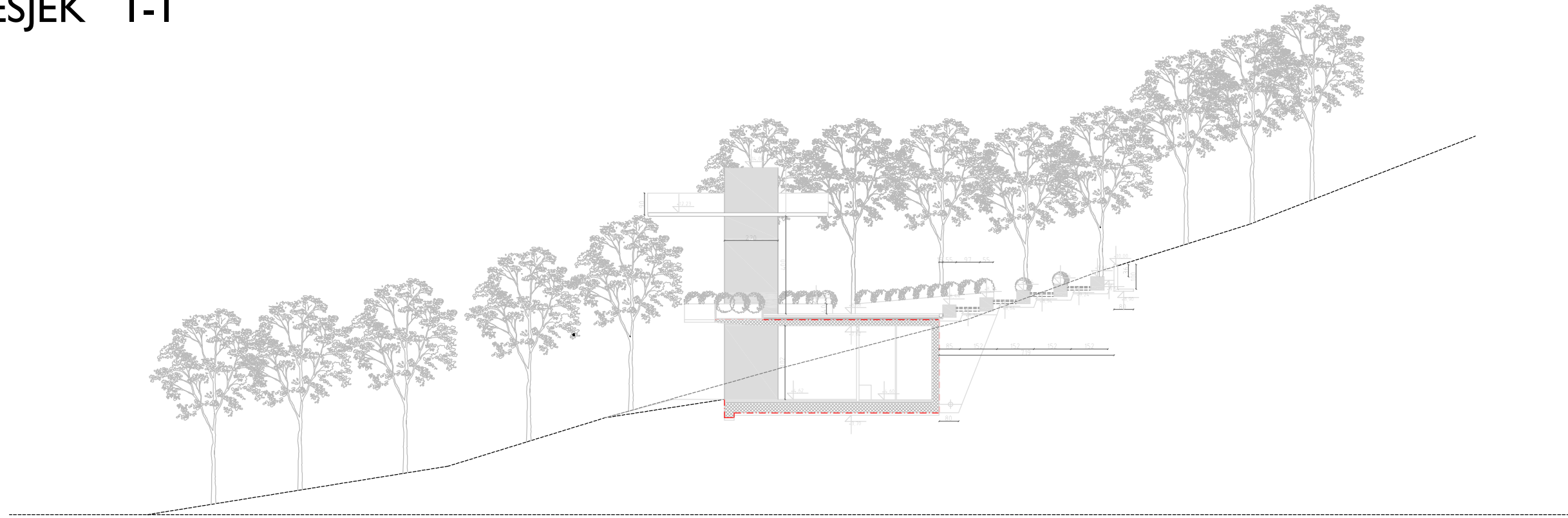

PRESJEK 2-2

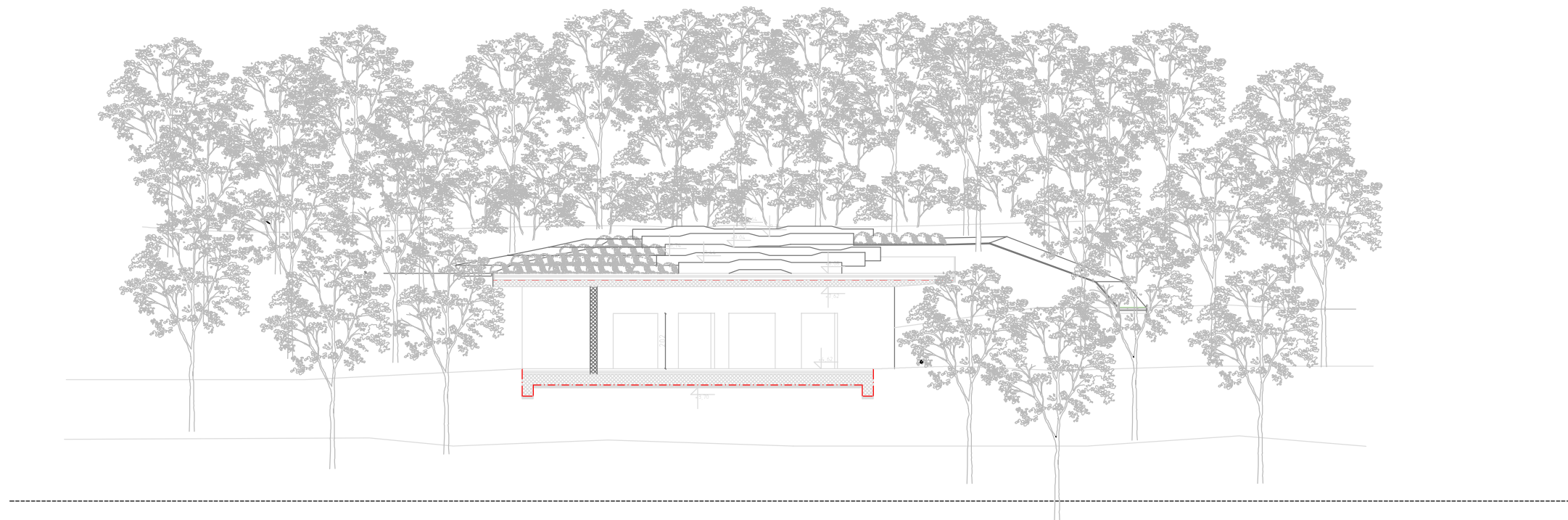

# KARAKTERISTIČNI PRESJEK 3-3

MI:50

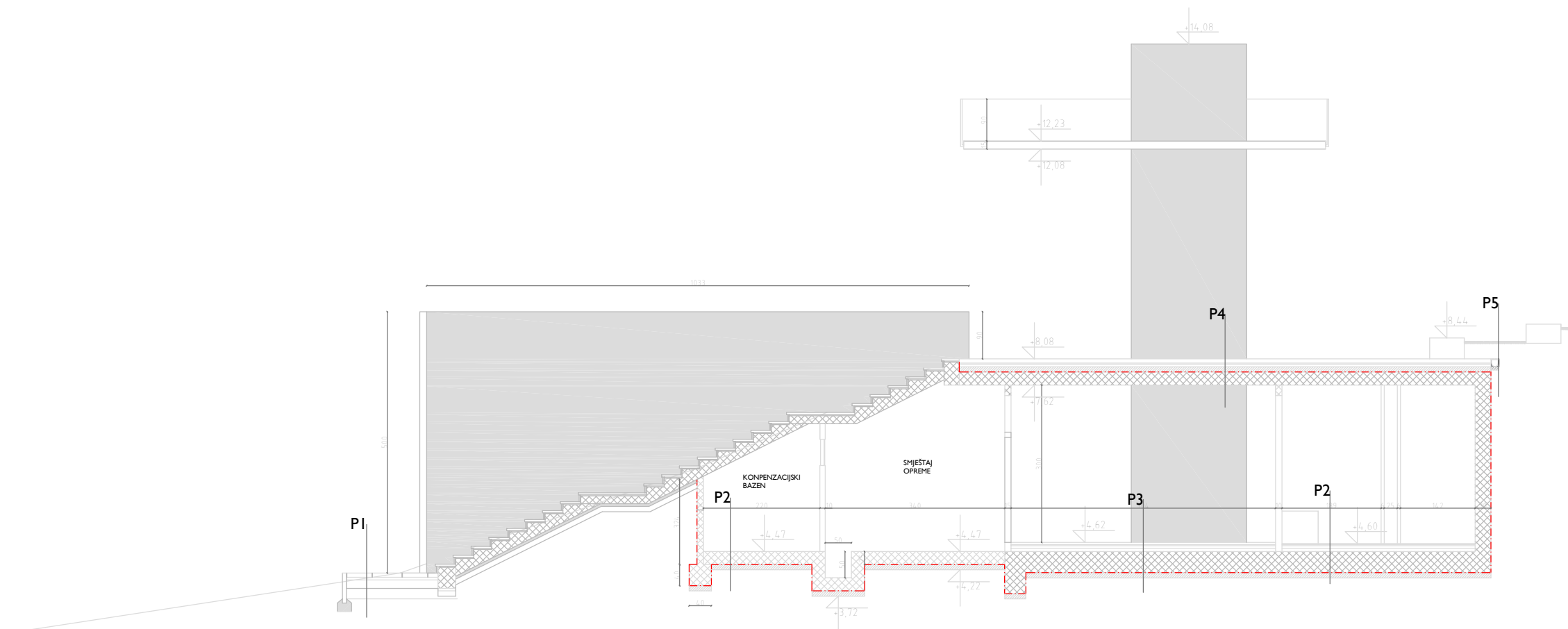

P1

1. BETONSKE PLOČE  
30x30x8 cm
2. KAMENI AGREGAT 2-4mm
3. RAZDIJELNI SLOJ
4. TUCANIK 15cm
5. GEOTEKSTIL
6. POSTELJICA

P2

1. KERAMIČKE PLOČICE  
30x50x1
2. CEMENTNI MORT 2 cm
3. ESTRIH 5 cm
4. FIBRAN U PADU 6cm
5. ARMIRANO BETONSKA PLOČA 40 cm
6. HIDROIZOLACIJA
7. BETONSKA PODLOGA 10 cm
8. ŠLJUNAK 25
9. POSTELJICA

P3

1. BETONSKE PLOČE  
40x40x4 cm
2. CEMENTNI MORT 2 cm
3. ESTRIH 5 cm
4. FIBRAN U PADU 6cm
5. ARMIRANO BETONSKA PLOČA 40 cm
6. HIDROIZOLACIJA
7. BETONSKA PODLOGA 10 cm
8. ŠLJUNAK 25
9. POSTELJICA

P4

1. BETONSKE PLOČE  
40x40x4 cm
2. CEMENTNI MORT 2 cm
3. ESTRIH 5 cm
4. FIBRAN U PADU 10cm
5. HIDROIZOLACIJA
6. ARMIRANO BETONSKA PLOČA 25 cm

P5

1. TRAVNATA REŠETKA 5 cm
2. SUPSTRAT 10cm
3. TUCANIK 15cm
4. GEOTEKSTIL
5. POSTELJICA

# DETALJ TRIBINE

MI:10

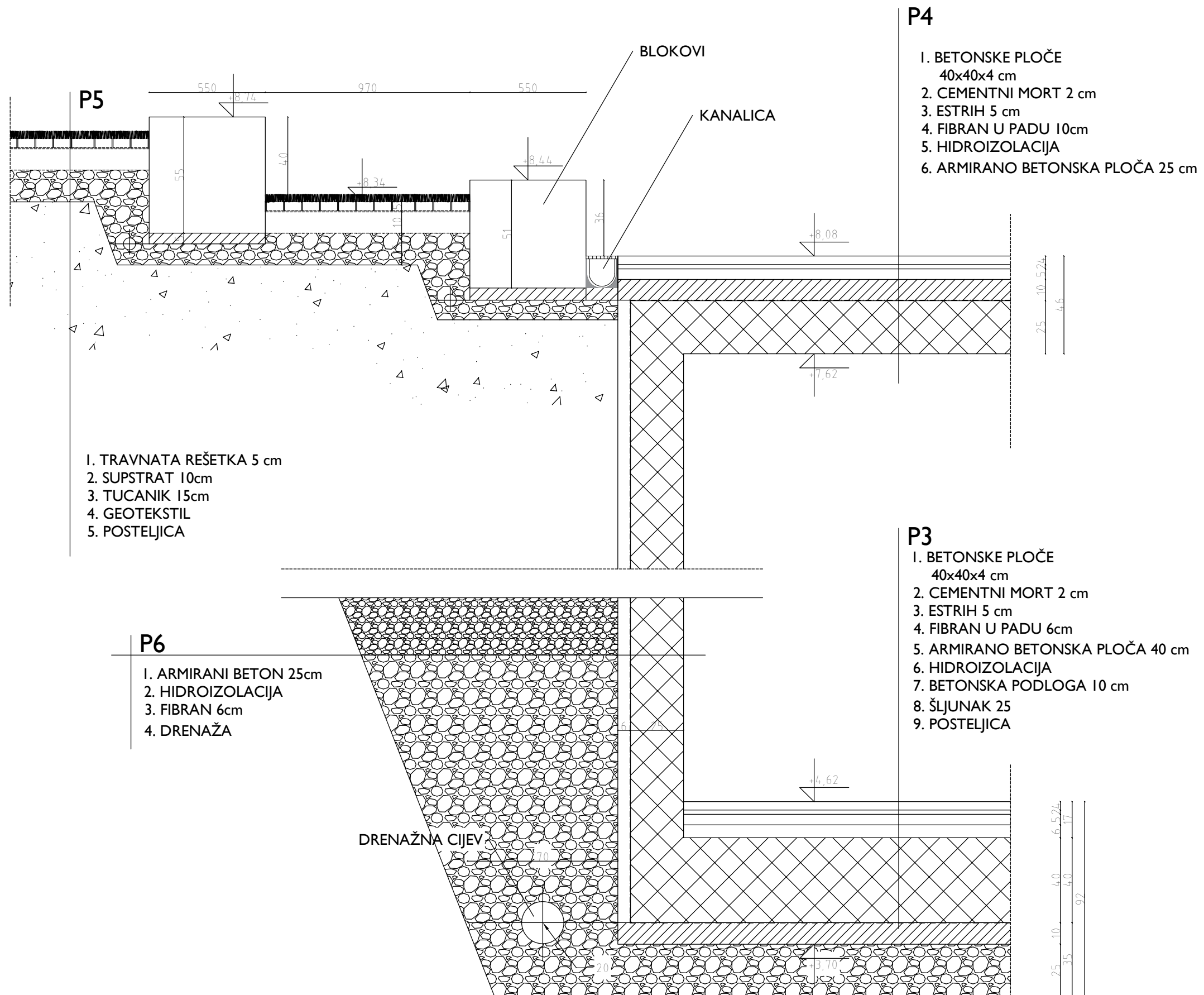

# DETALJ STUBIŠTA

MI:10

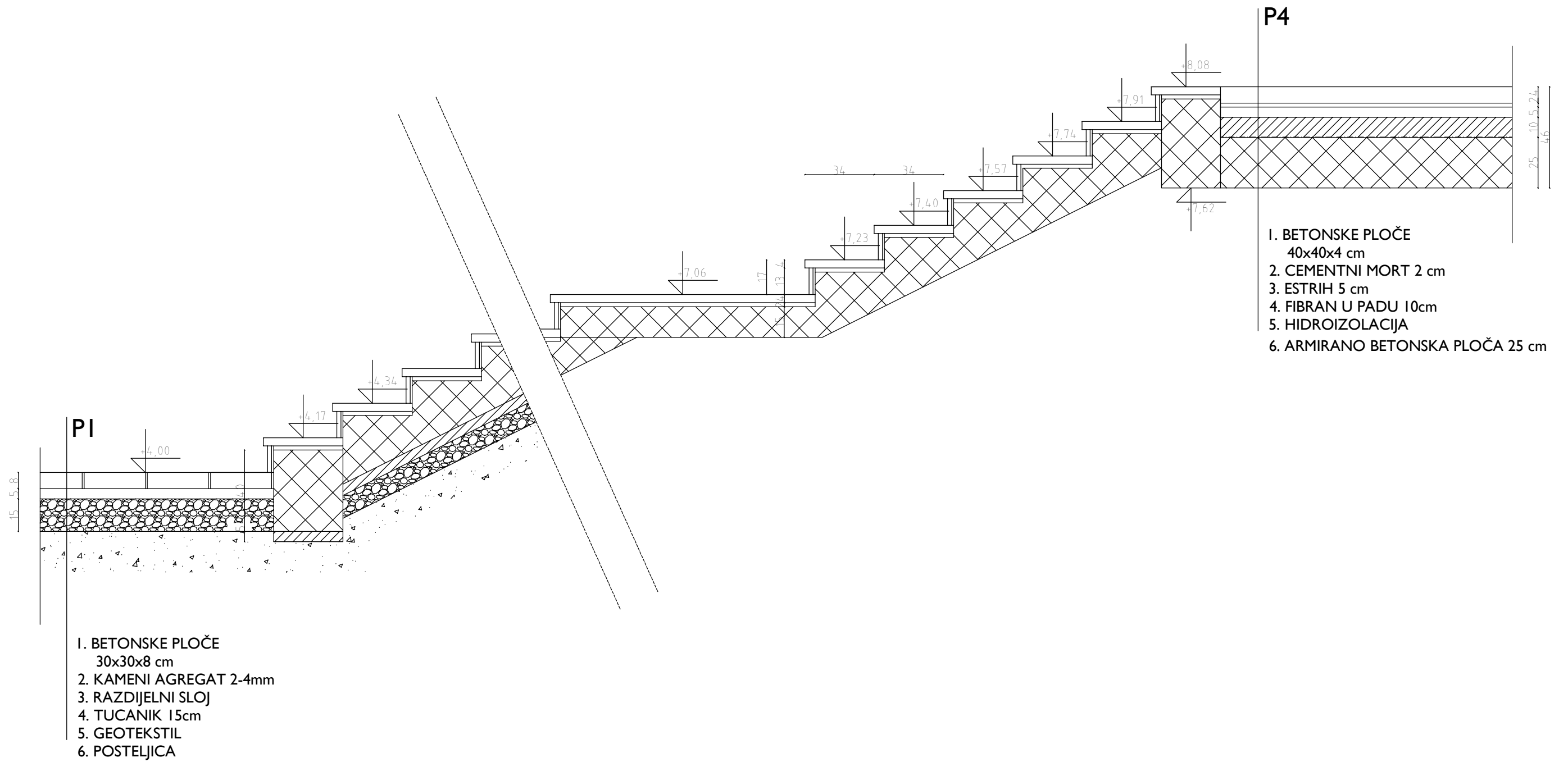



**KONSTRUKCIJE I MATERIJALI U KRAJOBRAZNOJ  
ARHITEKTURI**

AKADEMSKA GODINA 2019/2020

**DATUM PREDAJE: 15.07.2020 - ISPRAVAK**

STUDENT: ZVONIMIR MIHETEC

**NOSITELJ KOLEGIJA: doc.art. STANKO STERGARŠEK,  
dipl.ing.arh.**

**ASISTENT: ANETA MUDRONJA PLETENAC dipl.ing.arh.**

# SADRŽAJ

IDEJNO RJEŠENJE (M 1:500)	01
PRESJECI (M 1:500)	02
IDEJNO RJEŠENJE (M 1:200)	03
TLOCRT S OSNOVNIM DIMENZIJAMA	04
PRESJECI (M 1:200)	05
DETALJ STEPENICA I TRIBINA	06
DETALJ STEPENICA I TRIBINA	07
DETALJ STEPENICA I TRIBINA	08
DETALJ TRIBINA I STEPENICA S OSNOVNIM DIMENZIJAMA	09
PRESJEK STAZE	10
TLOCRTNI PRIKAZ PAVILJONSKOG PROSTORA	11
DETALJ ŠTANDA	12
DETALJI POZORNICE	13
KATALOG MATERIJALA	14
3D PRIKAZ	15

# IDEJNO RJEŠENJE

M 1:500

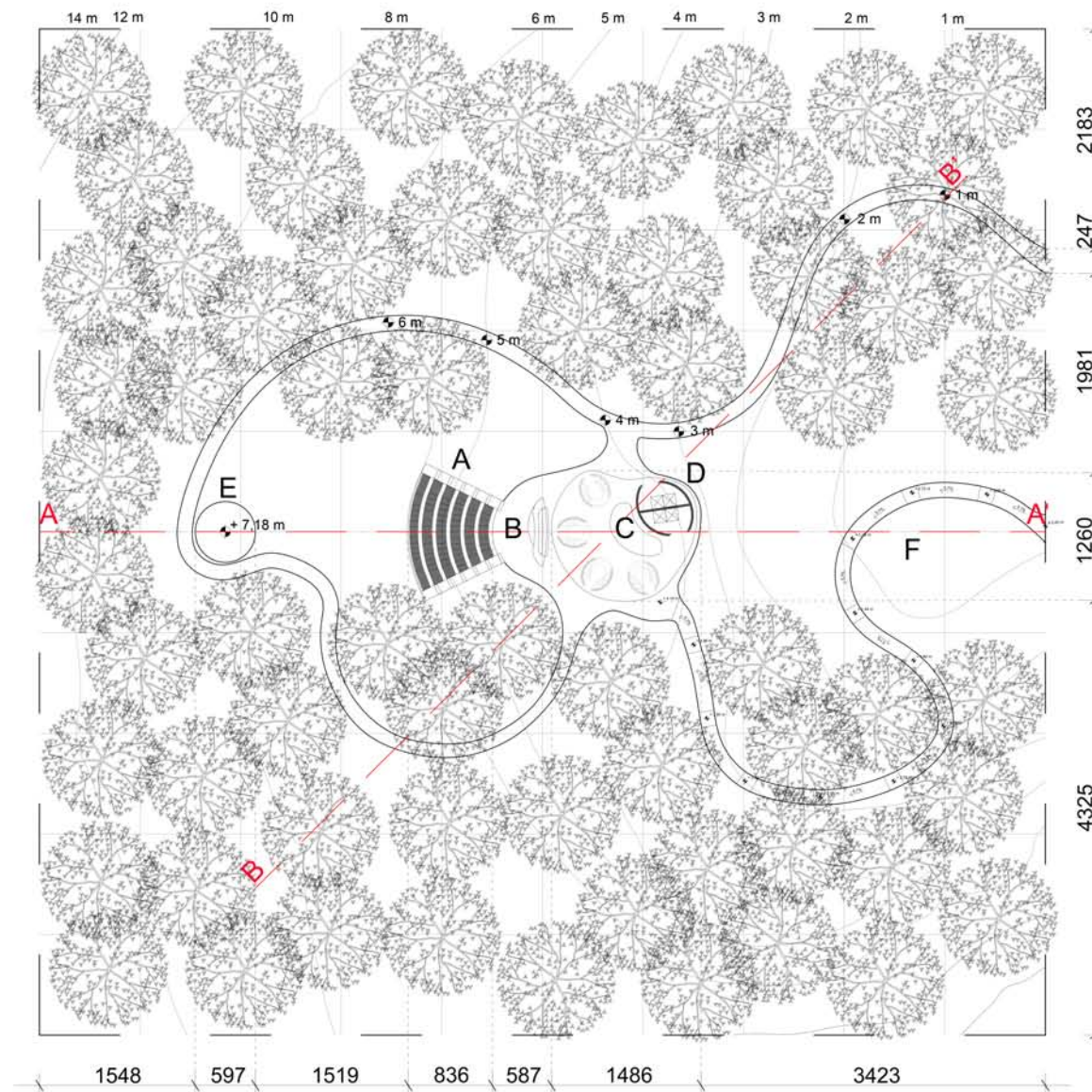

## LEGENDA

- A AMFITEATAR / TRIBINE
- B KINO PLATNO / POZORNICA
- C PAVILJON / ŠTANDOVI
- D TOALET
- E OBELISK
- F RAMPA ZA OSOBE S POTEŠKOĆAMA U KRETANJU

- RUB STAZE
- SLOJNICE
- - - PRESJECI

KONSTRUKCIJE I MATERIJALI U KRAJOBRAZNOJ ARHITEKTURI

PREDIPLOMSKI STUDIJ KRAJOBRAZNA ARHITEKTURA

SVEUČILIŠTE U ZAGREBU AGRONOMSKI FAKULTET

AKADEMSKA GODINA 2019/2020

# PRESJECI

M 1:500

## LEGENDA

- A OBELISK
- B AMFITEATAR / TRIBINE
- C PAVILJON / ŠTANDOVI

— POSTOJEĆI TEREN

### PRESJEK A - A'

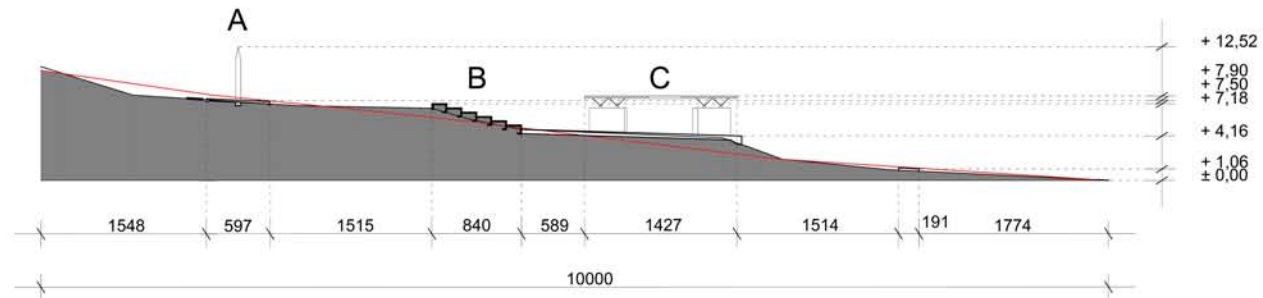

### PRESJEK B - B'

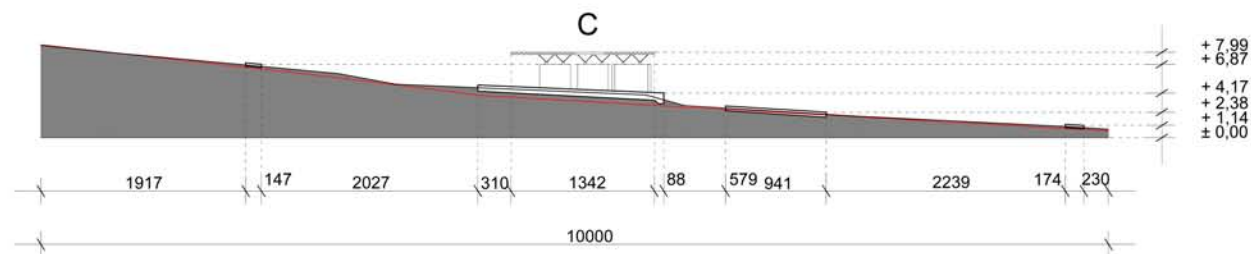

KONSTRUKCIJE I MATERIJALI U KRAJOBRAZNOJ  
ARHITEKTURI  
PREDIPLOMSKI STUDIJ KRAJOBRAZNA ARHITEKTURA

SVEUČILIŠTE U ZAGREBU AGRONOMSKI FAKULTET

AKADEMSKA GODINA 2019/2020



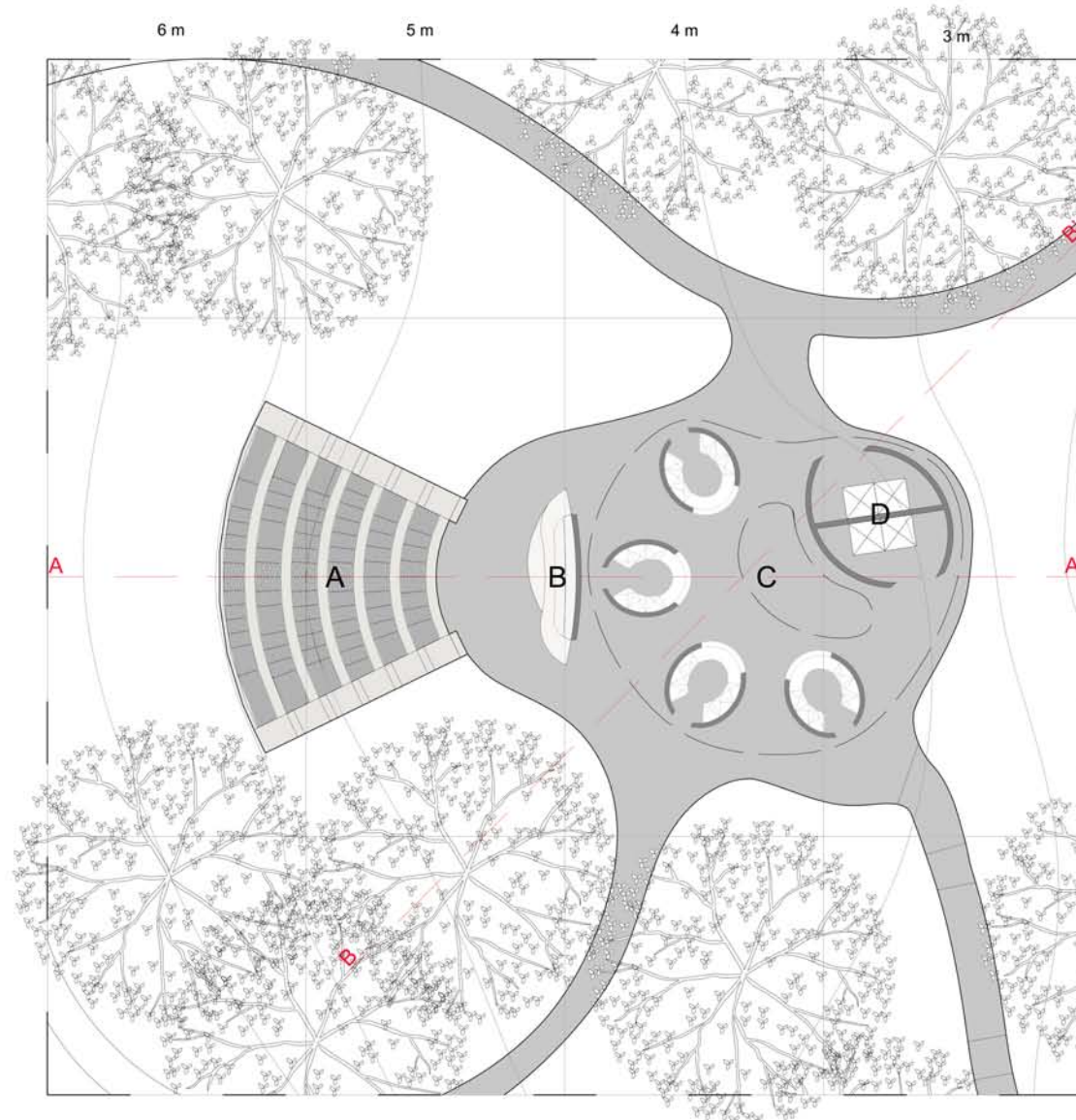

# IDEJNO RJEŠENJE

M 1:200



## LEGENDA

- A AMFITEATAR / TRIBINE
- B KINO PLATNO / POZORNICA
- C PAVILJON / ŠTANDOVI
- D TOALET
-  KONSTRUKCIJA / POZORNICA
-  DEKORATIVNI KULIR BETON
-  KULIR PLOČE / TRIBINE
-  AB ZIDOVI
-  LINIJA PRESJEKA
-  SLOJNICE
-  KROV PAVILJONA

KONSTRUKCIJE I MATERIJALI U KRAJOBRAZNOJ  
ARHITEKTURI

PREDIPLOMSKI STUDIJ KRAJOBRAZNA ARHITEKTURA

SVEUČILIŠTE U ZAGREBU AGRONOMSKI FAKULTET

AKADEMSKA GODINA 2019/2020

# TLOCRT S OSNOVNIM DIMENZIJAMA

M 1:200

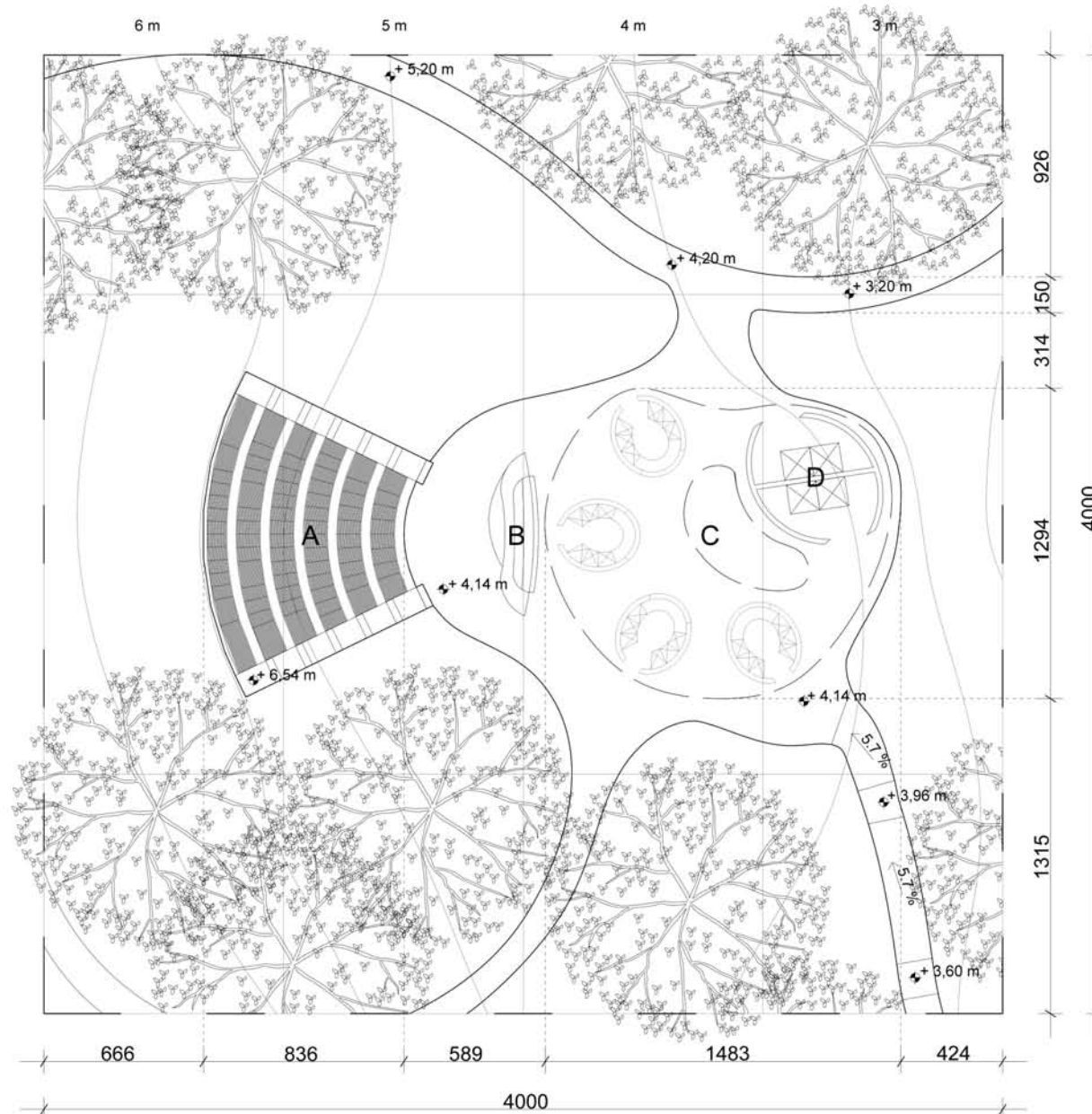

## LEGENDA

- A AMFITEATAR / TRIBINE
- B KINO PLATNO / POZORNICA
- C PAVILJON / ŠTANDOVI
- D TOALET

— SLOJNICE

— KROV PAVILJONA

KONSTRUKCIJE I MATERIJALI U KRAJOBRAZNOJ ARHITEKTURI

PREDIPLOMSKI STUDIJ KRAJOBRAZNA ARHITEKTURA

SVEUČILIŠTE U ZAGREBU AGRONOMSKI FAKULTET

AKADEMSKA GODINA 2019/2020

# PRESJECI

M 1:200

## LEGENDA

A AMFITEATAR / TRIBINE

B PAVILJON / ŠTANDOVI

TEMELJI

PRESJEČENI TEREN

LINIJA PRESJEKA

TEREN

### PRESJEK A - A'

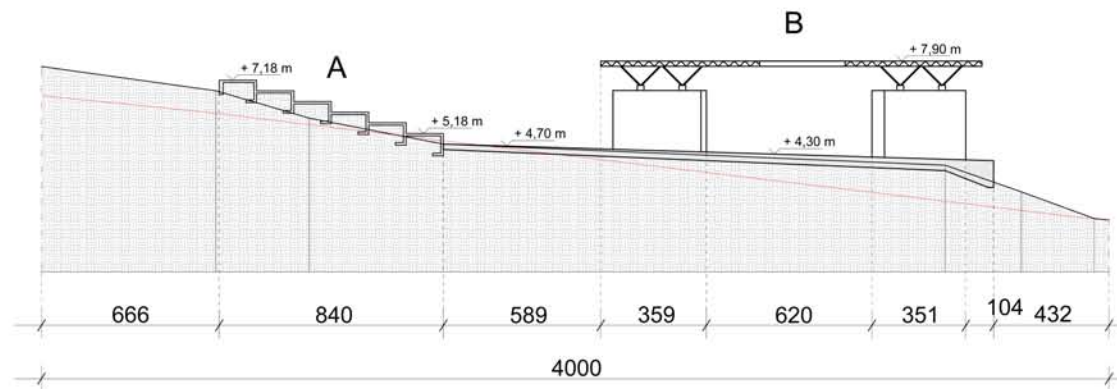

### PRESJEK B - B'

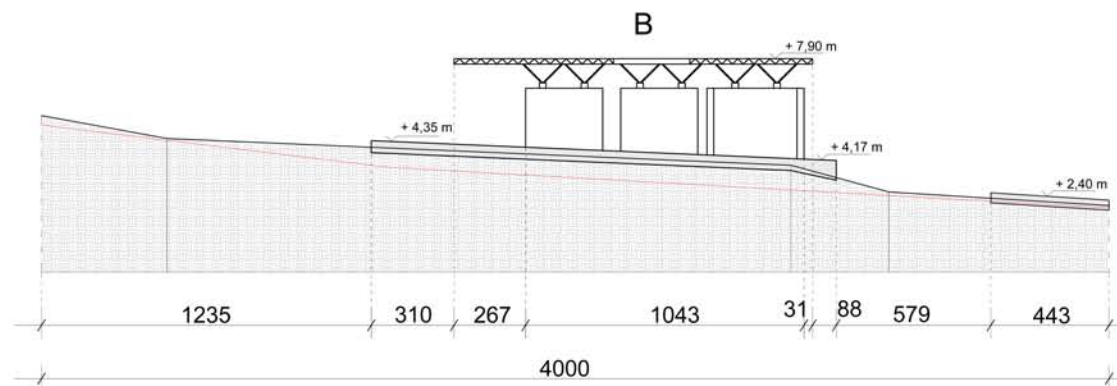

KONSTRUKCIJE I MATERIJALI U KRAJOBRAZNOJ  
ARHITEKTURI  
PREDIPLOMSKI STUDIJ KRAJOBRAZNA ARHITEKTURA

SVEUČILIŠTE U ZAGREBU AGRONOMSKI FAKULTET

AKADEMSKA GODINA 2019/2020





# DETALJ STEPENICA I TRIBINA

M 1:20

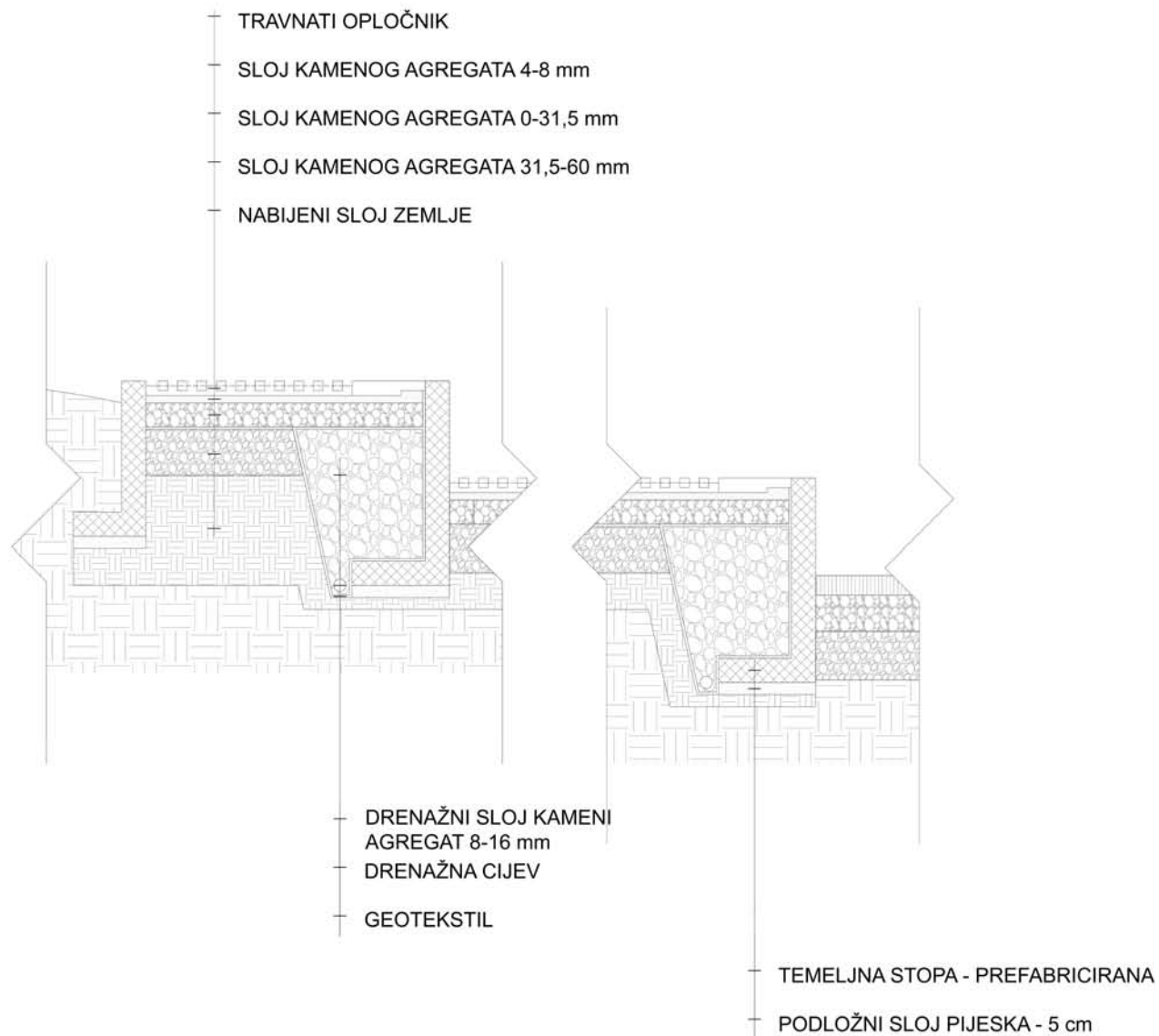

KONSTRUKCIJE I MATERIJALI U KRAJOBRAZNOJ  
ARHITEKTURI  
PREDIPLOMSKI STUDIJ KRAJOBRAZNA ARHITEKTURA

SVEUČILIŠTE U ZAGREBU AGRONOMSKI FAKULTET

AKADEMSKA GODINA 2019/2020

# DETALJI STEPENICA I TRIBINA S OSNOVNIM DIMENZIJAMA

M 1:20

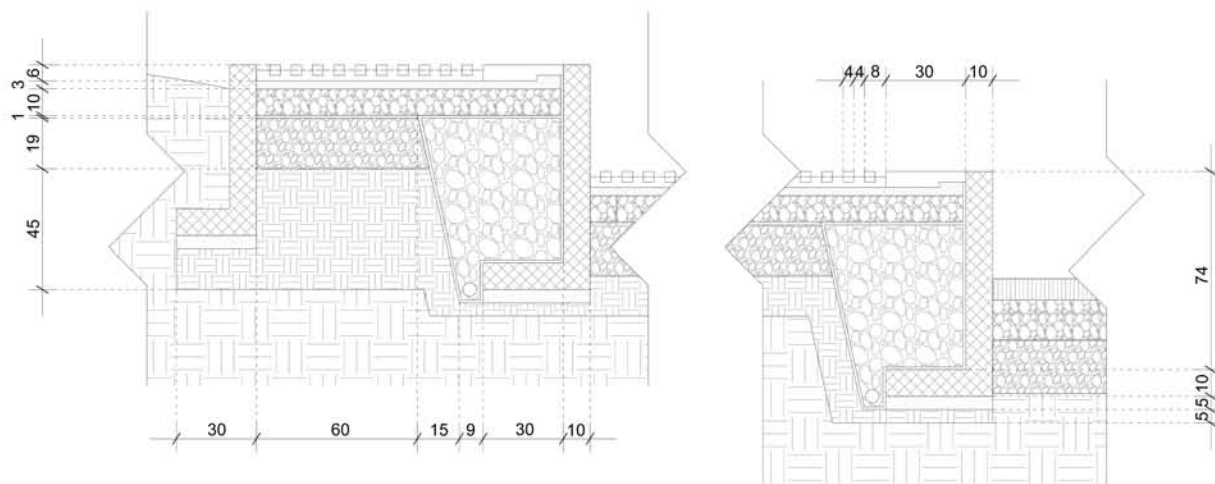

KONSTRUKCIJE I MATERIJALI U KRAJOBRAZNOJ  
ARHITEKTURI  
**PREDIPLOMSKI STUDIJ KRAJOBRAZNA ARHITEKTURA**

SVEUČILIŠTE U ZAGREBU AGRONOMSKI FAKULTET

AKADEMSKA GODINA 2019/2020

# PRESJEK STAZE

M 1:100

## LEGENDA

— — — — — POSTOJEĆI TEREN

## TLOCRT

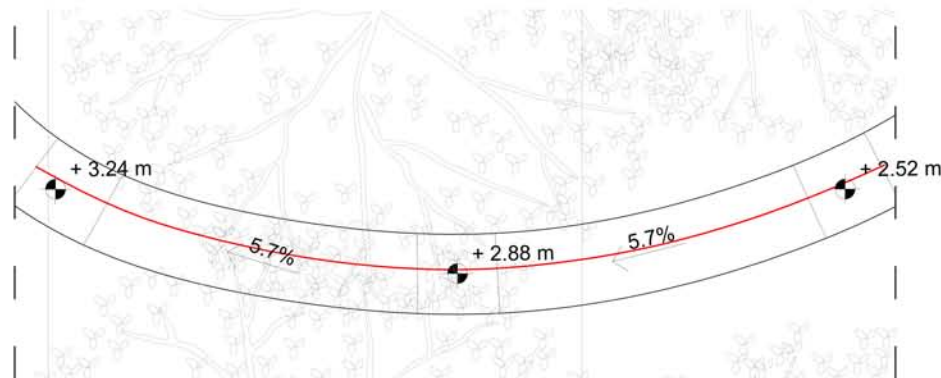

## PRESJECI

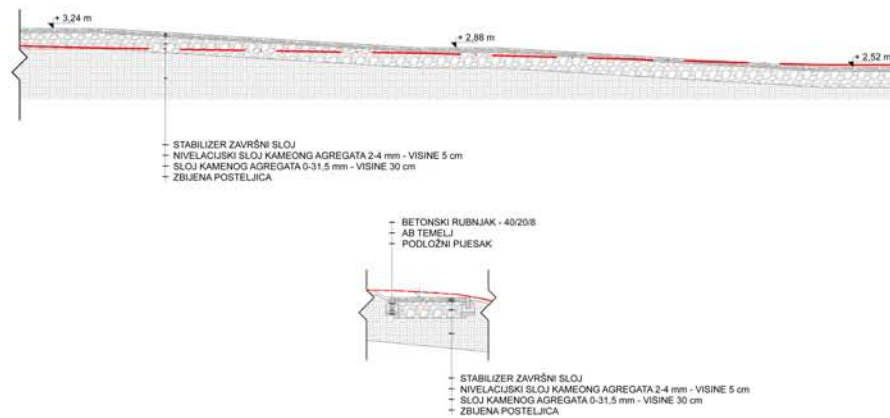

KONSTRUKCIJE I MATERIJALI U KRAJOBRAZNOJ  
ARHITEKTURI  
PREDIPLOMSKI STUDIJ KRAJOBRAZNA ARHITEKTURA

SVEUČILIŠTE U ZAGREBU AGRONOMSKI FAKULTET

AKADEMSKA GODINA 2019/2020



# TLOCRTNI PRIKAZ PAVILJONSKOG PROSTORA

M 1:100

## LEGENDA

- A MUŠKI TOALET
- B ŽENSKI TOALET
- C ŠTAND

 ARMIRANO BETONSKI  
ELEMENTI

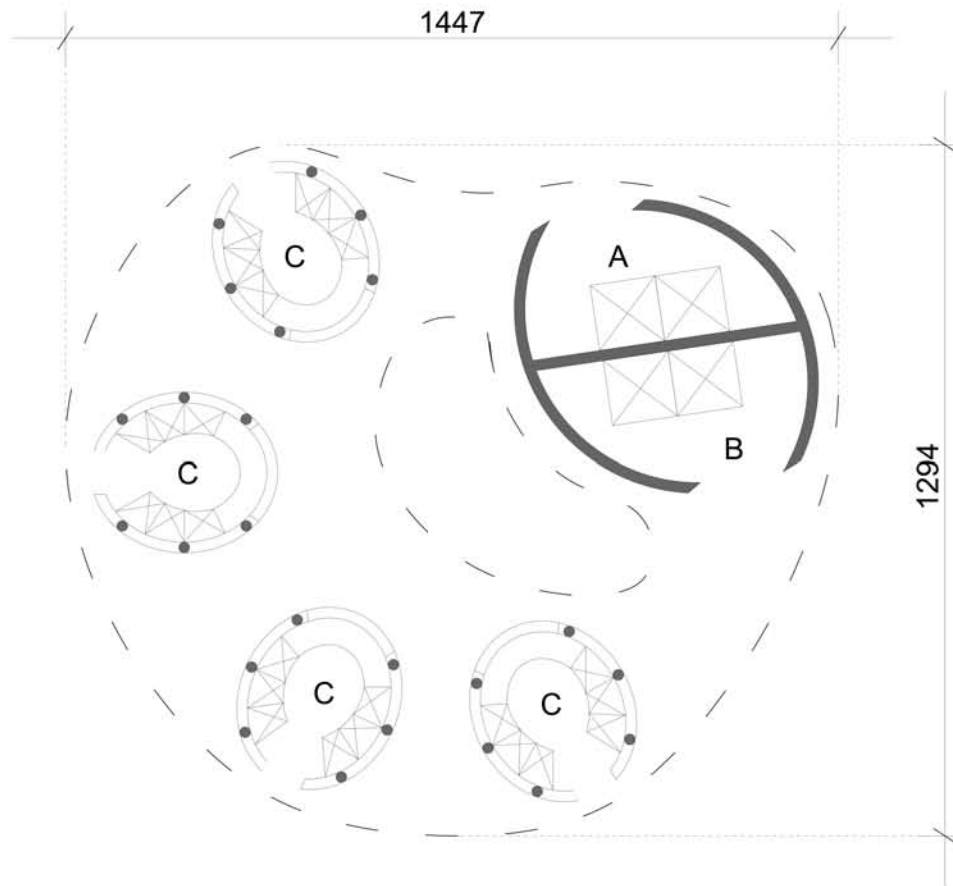

KONSTRUKCIJE I MATERIJALI U KRAJOBRAZNOJ  
ARHITEKTURI

PREDIPLOMSKI STUDIJ KRAJOBRAZNA ARHITEKTURA

SVEUČILIŠTE U ZAGREBU AGRONOMSKI FAKULTET

AKADEMSKA GODINA 2019/2020

# DETALJ ŠTANDA

M 1:100

## TLOCRT

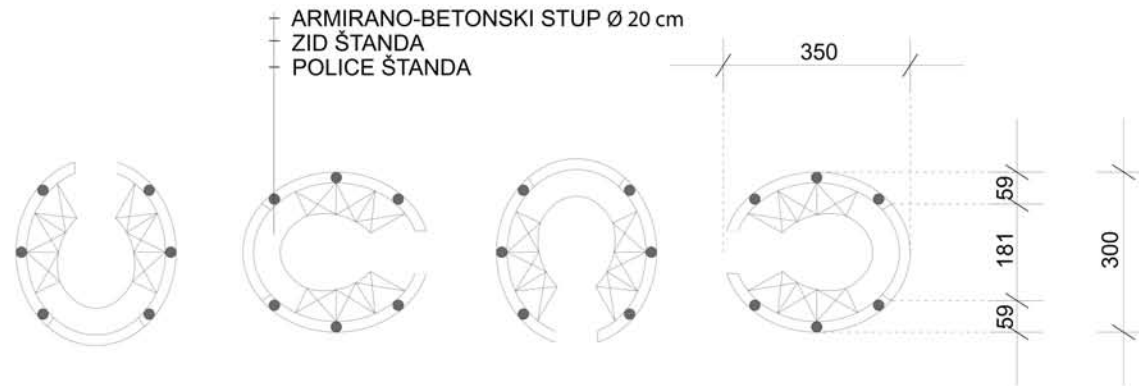

## POGLED

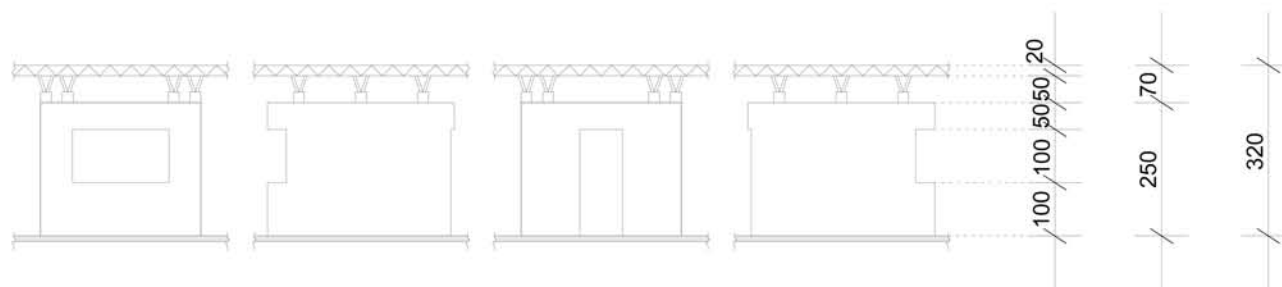

KONSTRUKCIJE I MATERIJALI U KRAJOBRAZNOJ  
ARHITEKTURI

PREDIPLOMSKI STUDIJ KRAJOBRAZNA ARHITEKTURA

SVEUČILIŠTE U ZAGREBU AGRONOMSKI FAKULTET

AKADEMSKA GODINA 2019/2020

# DETALJI POZORNICE

M 1:100

## LEGENDA



ZID ZA PROJEKCIJU

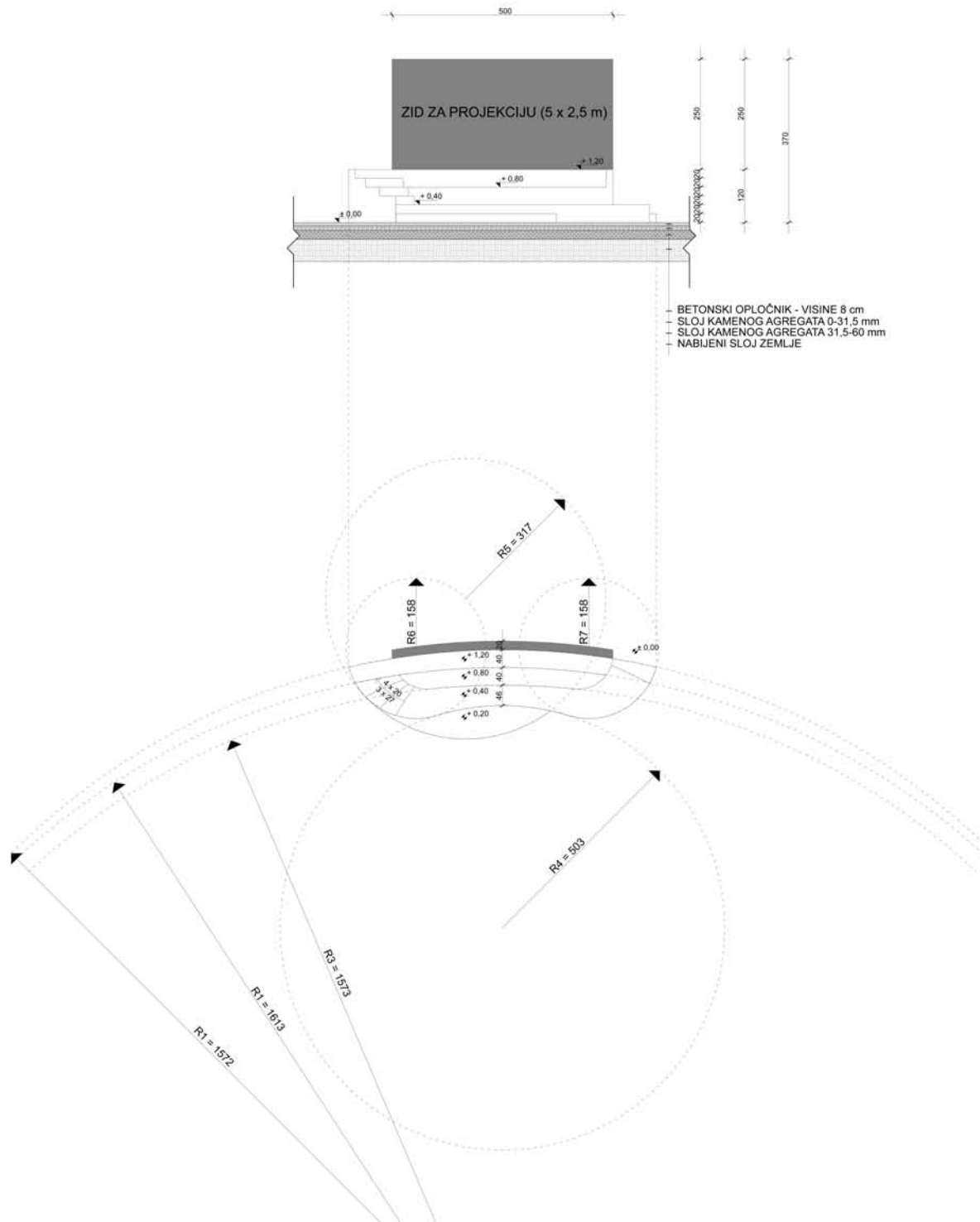









KONSTRUKCIJE I MATERIJALI U KRAJOBRAZNOJ  
ARHITEKTURI  
PREDIPLOMSKI STUDIJ KRAJOBRAZNA ARHITEKTURA

SVEUČILIŠTE U ZAGREBU AGRONOMSKI FAKULTET

AKADEMSKA GODINA 2019/2020

# KATALOG MATERIJALA

	<b>ARMIRANI STUPOVI</b> <ul style="list-style-type: none"><li>- dio konstrukcije štandova</li><li>- armirano-betonski stupovi</li><li>- isključivo konstrukcijske funkcije</li></ul>		<b>OPLOČENJE</b> <ul style="list-style-type: none"><li>- uz pozornicu, štandove</li><li>- prefabricirane</li><li>- bojom ne odskaku od ostalog opločenja</li></ul>
	<b>BETONSKE PLOČE</b> <ul style="list-style-type: none"><li>- dio tribina, stepenice</li><li>- dekorativni beton, kulir</li><li>- bijela nijansa</li></ul>		<b>POZORNICA</b> <ul style="list-style-type: none"><li>- bijele akrilne ploče</li><li>- vezane na konstrukciju</li><li>- estetsko-funkcionalne</li><li>- sakrivaju konstrukciju, služe kao obložni element</li></ul>
	<b>LIM</b> <ul style="list-style-type: none"><li>- dio konstrukcije štandova</li><li>- obložni lim</li><li>- blagi plavkasto-sivi odsjaj</li></ul>		<b>STABILIZER</b> <ul style="list-style-type: none"><li>- prirodno organsko vezivo</li><li>- povezuje kameni agregat 4-8 mm</li><li>- za staze, rampu</li></ul>
	<b>KROV PAVILJONA / ŠTANDOVA</b> <ul style="list-style-type: none"><li>- Ethylene tetrafluoroethylene (ETFE)</li><li>- krov, nadstrešnica</li><li>- zaštitna funkcija</li></ul>		<b>TRAVNATI OPLOČNICI</b> <ul style="list-style-type: none"><li>- linijski, rešetkasti elementi</li><li>- dekorativni beton</li><li>- materijalistički povezani s ostalim opločenjem</li></ul>

KONSTRUKCIJE I MATERIJALI U KRAJOBRAZNOJ  
ARHITEKTURI

PREDIPLOMSKI STUDIJ KRAJOBRAZNA ARHITEKTURA

SVEUČILIŠTE U ZAGREBU AGRONOMSKI FAKULTET

AKADEMSKA GODINA 2019/2020

POGLED S VRHA TRIBINA (ZAPAD-ISTOK)

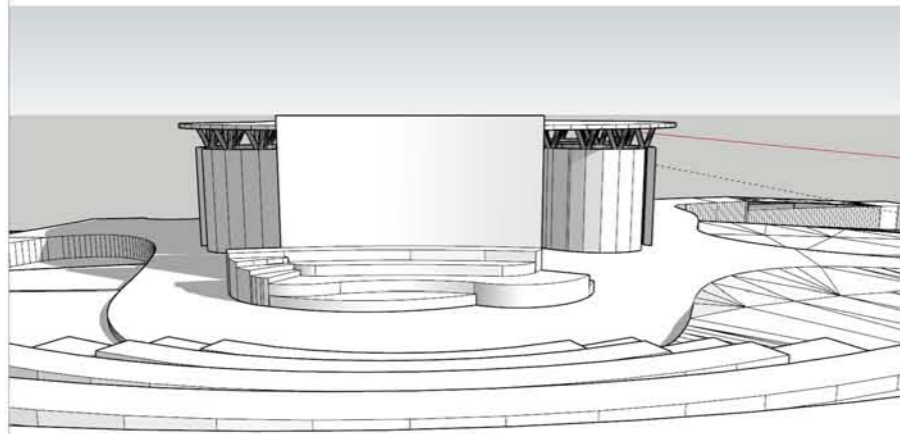

POGLED S STAZE (IZ SMJERA SJEVERO-ZAPADA)

POGLED S DNA OBUHVATA (IZ SMJERA ISTOKA)

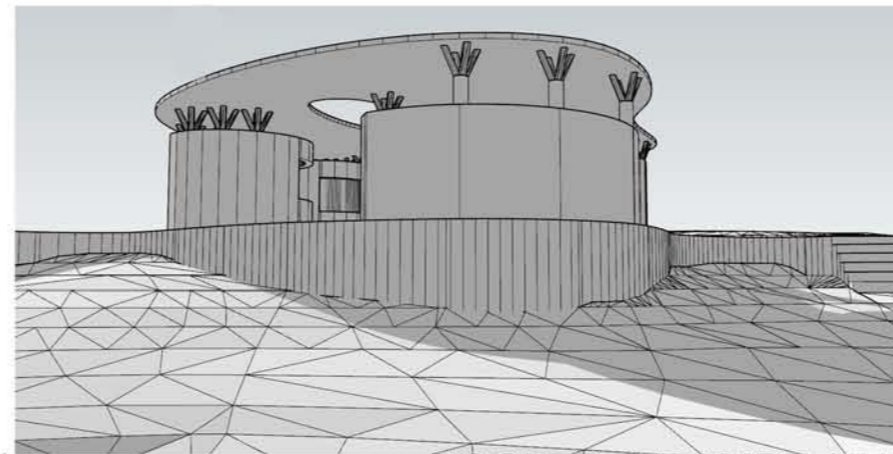

POGLED S RAMPE (JUGO-ISTOK)

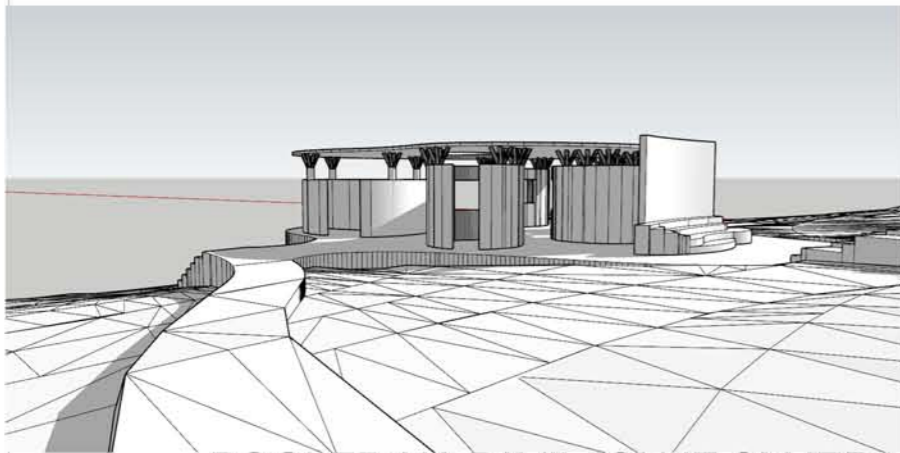

POGLED NA PAVILJON IZ SMJERA SJEVERA

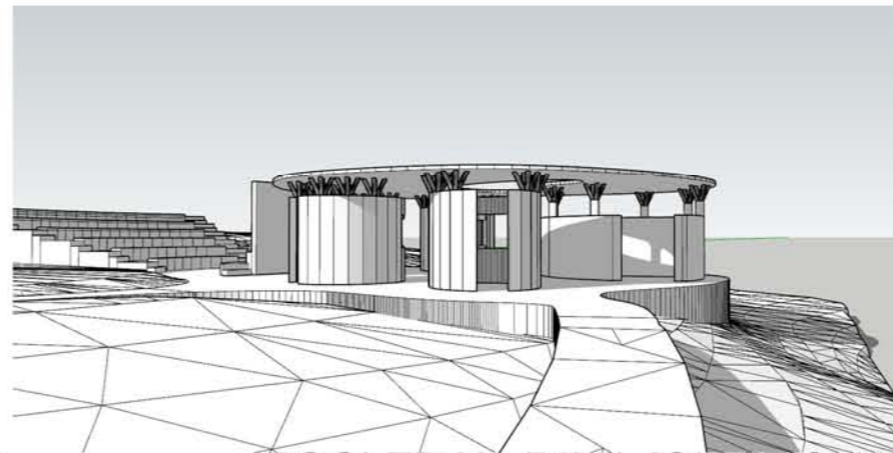

POGLED NA PAVILJON (IZ SMJERA JUGA)

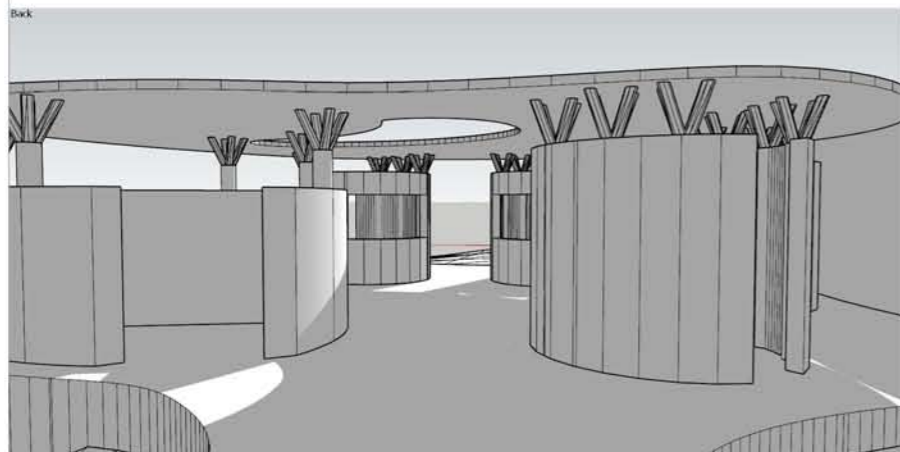

POGLED NA PAVILJON (IZ SMJERA SJEVERO-ISTOKA)

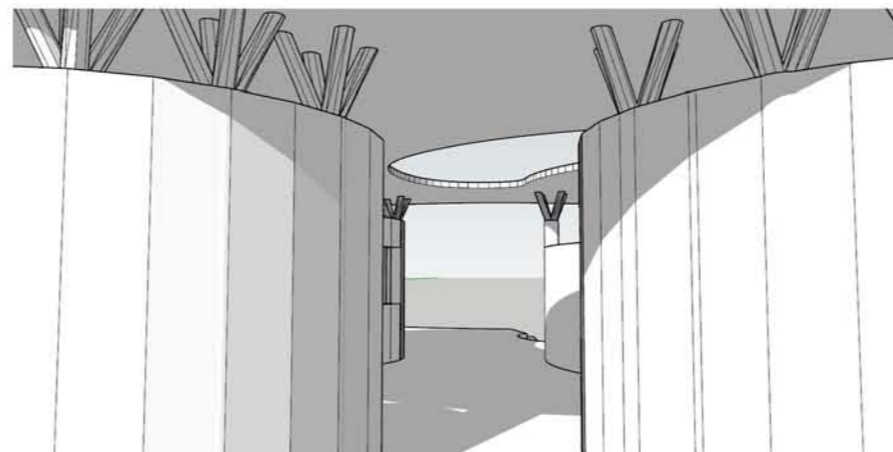

POGLED NA PAVILJON (IZ SMJERA JUGO-ZAPADA)

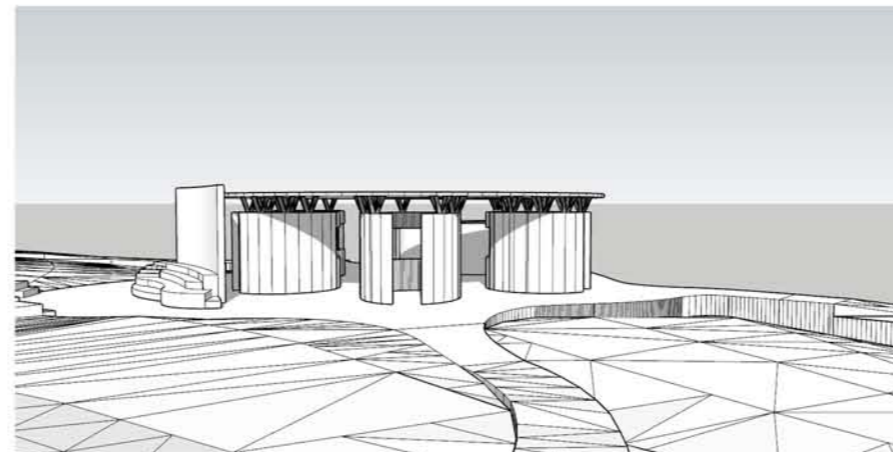
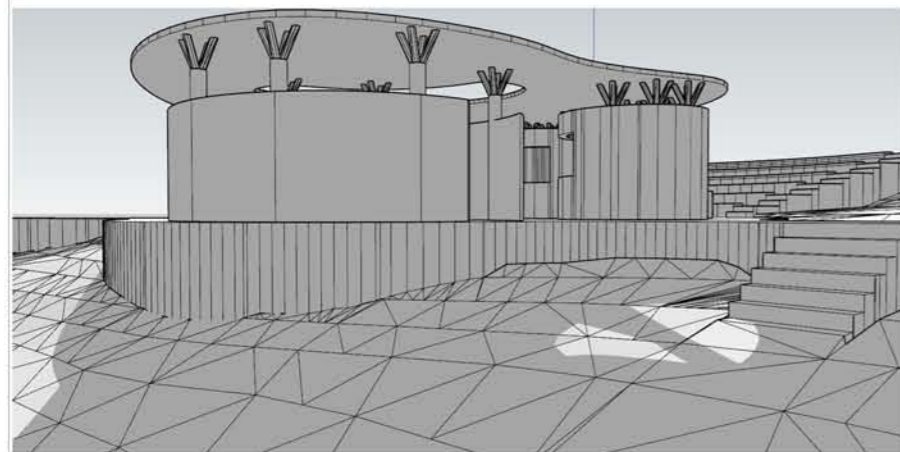

# 3D PRIKAZ

KONSTRUKCIJE I MATERIJALI U KRAJOBRAZNOJ  
ARHITEKTURI  
PREDIPLOMSKI STUDIJ KRAJOBRAZNA ARHITEKTURA  
SVEUČILIŠTE U ZAGREBU AGRONOMSKI FAKULTET  
AKADEMSKA GODINA 2019/2020